

brother®

FAX

615

625

635

675

715M

725M

**OWNER'S
MANUAL**

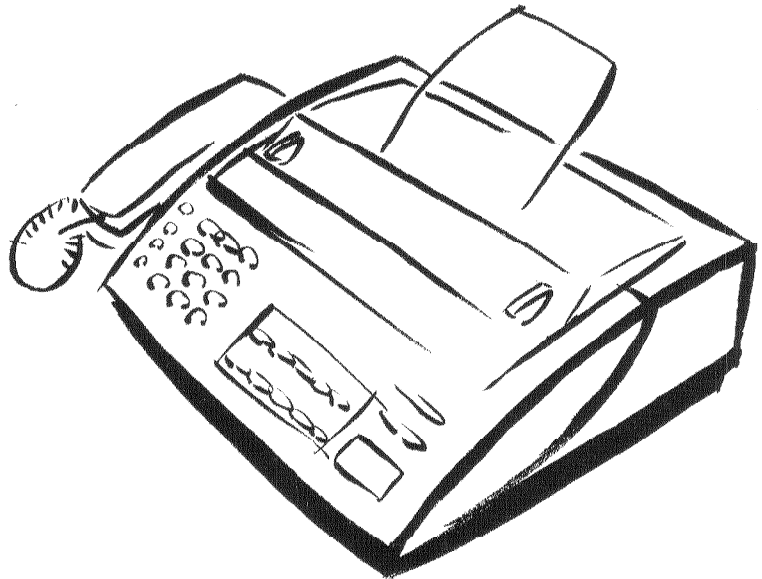

CONTENTS

.....

Chapter 1.	SETUP & PREPARATION BEFORE USE
Chapter 2.	THE CONTROL PANEL KEYS
Chapter 3.	HOW TO USE ON-SCREEN PROGRAMMING (OSP) AND HELP KEY
Chapter 4.	TELEPHONE FUNCTION SETTINGS
Chapter 5.	USING THE UNIT AS A TELEPHONE
Chapter 6.	SENDING FAXES
Chapter 7.	RECEIVING FAXES AND OTHER CALLS
Chapter 8.	POLLING
Chapter 9.	HOW TO USE COPY FUNCTIONS
Chapter 10.	PRINTING REPORTS AND LISTS
Chapter 11.	REGULAR MAINTENANCE AND TROUBLESHOOTING
Chapter 12.	IMPORTANT INFORMATION
Chapter 13.	INDEX
Chapter 14.	SPECIFICATIONS

These machines are made for use in the USA only. We can not recommend using them overseas because it may violate the Telecommunications Regulations of that country and the power requirements of your fax machine may not be compatible with the power available in foreign countries. **Using USA models overseas is at your own risk and will void your warranty.**

How to Use This Owner's Manual

Thank you for purchasing a Brother fax machine. This fax machine has been designed to be simple to use, but you can use it to its fullest potential by taking some time to read this owner's manual. You will be ready to use the fax machine as soon as you read the first four chapters. Then you can refer to topics in the remaining chapters, as needed.

Structure of the Manual

- **Chapter 1**
How to set up the fax machine and what you need to know before you use it.
- **Chapters 2~7**
Basic operations, how to send and receive faxes.
- **Chapter 8**
How to do polling.
- **Chapter 9**
How to copy.
- **Chapter 10**
How to print reports and lists.
- **Chapters 11~12**
Important Information.

Finding Information in the Owner's Manual

- Use the **table of contents**. This side of the manual is coded so you can find topics easily.
- If there is a **key on the fax machine** you are not familiar with, refer to **chapter 2**.
- To find information about a function, refer to the "**Function Selection Table**" in **chapter 3**.
- If you have **trouble**, refer to **chapter 11** on troubleshooting.
- Use the **chapter 13 index**.

Test Sheet Procedure

Please fill out the TEST SHEET and fax it to **1-908-469-4547** as your first transmission. This will verify that your fax machine is properly installed.

When this document is received at Brother Diagnostic Center, a confirmation sheet will be sent back to your machine from Brother Automatic Fax Back Response System. Be sure to set up your "Station ID". (See page 4-3.)

FAX NO. : **1-908-469-4547** (Fax Transmission Only)
TEL NO. : **1-800-284-4FAX** (Voice Phone Only)
1-800-284-4329

CONTENTS

• FOR YOUR INFORMATION

Chapter 1.

❖ SETUP & PREPARATION BEFORE USE	1-1
Common Misunderstandings about Fax Machines	1-1
What Are Fax Tones?	1-1
Why Does the Ring Change in F/T Mode?	1-1
What is the Fax "Handshake"?	1-2
What Causes the Transmission Verification Report to Print "Result: NG"?	1-2
Is This a Fax Call?	1-2
How Can I Send the Call to My Fax Machine?	1-3
What is the Difference Between Automatic and Manual Transmission? ..	1-3
What is the Difference Between Automatic and Manual Dialing?	1-3
What Should I Do If My Fax Machine Does Not Have a Dial Tone?	1-3
Choosing a Suitable Place for Your Fax Machine	1-4
The Good Places... ..	1-4
And the Bad Places... ..	1-4
Packing List	1-5
Setting up Your Fax Machine	1-5
• Roll Over Phone Lines	1-7
• Two Line Phone System	1-7
• Converting Telephone Wall Outlets	1-7
• Installing a Fax Machine, Two Line TAD and Two Line Telephone	1-8
• Multi Line Connections (PBXs)	1-9
• Connecting to a Private Branch Exchange	1-9
• Custom Features on Your Phone Line	1-9

Chapter 2.

❖ THE CONTROL PANEL KEYS	2-1
TELEPHONE AREA	2-2
ONE-TOUCH AREA	2-3
FUNCTION AND USER SETTING AREA	2-4

Chapter 3.

❖ HOW TO USE ON-SCREEN PROGRAMMING (OSP) AND HELP KEY	3-1
User-friendly Programming	3-1
On-screen Programming (OSP)	3-1
Using the Function Mode to Access On-screen Programming (OSP)	3-1
Alternating Displays for On-screen Programming (OSP)	3-2
Function Selection Table	3-2
Help Key	3-6
How to print a Help List	3-6
How to Enter Text in Function Mode	3-8
How to Enter Special Characters, Symbols and Punctuation Marks in Function Mode	3-9

Chapter 4.

❖ TELEPHONE FUNCTION SETTINGS	4-1
Setting the Dialing Mode (Tone/Pulse)	4-1
Setting the Beeper Sound Level	4-1
Setting the Date and Time	4-2
Setting the Station ID	4-3
• Printing Page Headers	4-4
Storing One-Touch Dial Numbers	4-4

CONTENTS

Chapter 5.

- Types of Numbers 4-6
- Chain Dialing 4-6
- Storing Speed-Dial Numbers 4-6
 - When You Wish to Change the Stored One-Touch and Speed-Dial Numbers (During Step 4 on Page 4-5, 7) 4-8
 - Memory Storage 4-8
- Setting Up Number Groups (Only for 715M/725M) 4-8

Chapter 6.

- ❖ **USING THE UNIT AS A TELEPHONE** **5-1**
 - Manual Dialing 5-1
 - One-Touch Dialing 5-1
 - Speed Dialing 5-1
 - Using HOLD, PAUSE, # with the Telephone 5-1
 - On Hook Dialing 5-1
 - Optional Settings When You Send a Fax Manually 5-1
 - Searching the Telephone Index (Only for FAX-715M/725M) 5-2
- ❖ **SENDING FAXES** **6-1**
 - A) DOCUMENT BASICS 6-1
 - The Size of Your Documents 6-1
 - How to Insert the Document 6-1
 - The Auto Document Feeder (ADF) 6-2
 - Getting Ready to Send a Fax 6-2
 - SETTING THE RESOLUTION 6-2
 - SETTING THE CONTRAST 6-3
 - B) BASIC FAX TRANSMISSIONS 6-4
 - Sending a Fax 6-4
 - Talking to the Other Party When Sending a Fax 6-4
 - Sending a Fax Automatically 6-4
 - Sending a Fax Manually 6-5
 - Automatic and Manual Re-dialing 6-5
 - C) ADVANCED FAX TRANSMISSIONS 6-6
 - Sending a Fax by Using Quick-Scan (Memory Transmission) (Only for FAX-715M/725M) 6-6
 - If You Get a MEMORY FULL Message When Trying to Send a Fax by Using Quick-Scan 6-6
 - Delayed Transmission 6-7
 - Setting the Daily Timer (for Delayed Transmissions) 6-7
 - Broadcasting (Only for FAX-715M/725M) 6-8
 - Getting Familiar with the Broadcasting Function 6-8
 - Sending by Multi-Transmission (Only for FAX-715M/725M) 6-9
 - Interrupting the Timer and Polled Job 6-10
 - Canceling a Job 6-11
 - D) FAX TRANSMISSION OPTIONS 6-12
 - Setting the Overseas Mode 6-12
 - Setting Your Fax Machine for Multiple Resolution Transmission 6-12
 - Gray Scale (Only for FAX-615/625) 6-13
 - Sending a Fax with an Electronic Cover Page Message 6-14
 - The Comments Selection on the Cover Page 6-15
 - Customizing Your Cover Page Comment (Only for FAX-715M/725M) 6-15

CONTENTS

Chapter 7.

Printing the Cover Page	6-16
To Always Send a Cover Page	6-16
Sending a Fax When the Cover Page Is ON	6-17
Sending a Fax with Call Reservation	6-18
• Using the Call Reservation Function	6-19
Printing the Call Back Message	6-19
ECM (Error Correction Mode) (Only for FAX-715M/725M)	6-20
Error Re-Transmission (Only for FAX-715M/725M)	6-20
Next-FAX Reservation (Only for FAX-625/635/675/715M/725M)	6-21
❖ RECEIVING FAXES AND OTHER CALLS	7-1
A) BASIC SETUP TO RECEIVE FAXES	7-1
Selecting an Answer Mode	7-1
Manual Reception (MANUAL Mode)	7-2
Automatic Fax Only Reception (AUTO Mode)	7-2
Setting the Ring Delay	7-2
The F/T Switch (F/T Mode)	7-3
Setting the F/T Ring Time	7-4
Smoothing	7-4
Speaker Volume	7-5
Ring Volume	7-5
• Reception into Memory/Out of Paper Reception (Only for FAX-715M/725M)	7-6
B) REMOTE ACTIVATION	7-7
What is Remote Activation?	7-7
• Connecting an External or Extension Telephone	7-7
Using Remote Codes	7-7
Using the Activation Code:	7-8
Using the Deactivation Code:	7-8
Making the Remote Codes Easier to Use	7-8
Troubleshooting	7-8
Changing and Registering Remote Codes	7-9
C) CONNECTING A TELEPHONE ANSWERING DEVICE (TAD)	7-10
The TAD Mode	7-10
• Connecting an External TAD to the Unit	7-10
Example of the Sequence of External TAD Reception	7-11
Hookup	7-11
Recording the TAD's Outgoing Message (OGM)	7-11
D) DISTINCTIVE RINGING	7-12
Distinctive Ringing	7-12
What Is Distinctive Ringing?	7-12
Can My Fax Machine Use Distinctive Ringing?	7-12
Can I Change the Setting Later?	7-12
How Will the Fax Machine Treat All Other Numbers?	7-12
How Does the Distinctive Ringing Function Work?	7-13
Flowchart Sequence of an Incoming Call	7-13
What is the Advantage of Using the Distinctive Ringing Function?	7-13
Which Phone Number Should I Register?	7-13
What Must I Do to Set up Distinctive Ringing?	7-14

CONTENTS

	Setting the Distinctive Ringing Function	7-14
	How to Turn the Distinctive Ringing Function ON or OFF	7-15
	E) CALLER ID (Only for FAX-675/715M/725M)	7-16
	What is Caller ID?	7-16
	Advantages of Caller ID	7-16
	How Does the Caller ID Work?	7-16
	The Caller ID Appears on the Display When Your Telephone Rings	7-16
	The Caller ID is Stored in Your Machine's Memory (Only for FAX-715M/725M)	7-17
	Scanning through a Caller ID in the Memory (Only for FAX-715M/725M)	7-17
	• Clearing the Caller ID stored in Memory	7-18
	Printing the Caller ID List (Only for FAX-715M/725M)	7-18
Chapter 8.	❖ POLLING	8-1
	• What Is Polling?	8-1
	• How Does It Work?	8-1
	• When to Use Polling?	8-1
	Polling Another Fax Machine (Calling)	8-2
	Setting up Polled Waiting (Being Called)	8-2
	Secure Polling	8-3
	Polling Another Brother Fax Machine with Secure Code (Calling)	8-3
	Setting up Polled Waiting with Secure Polling (Being Called)	8-4
	Delayed Polling	8-5
	Setting up Polled Waiting with Quick-Scan (Only for FAX-715M/725M)	8-5
Chapter 9.	❖ HOW TO USE COPY FUNCTIONS	9-1
	Making a Single Copy	9-1
	Making Multiple Copies (Only for FAX-715M/725M)	9-2
	• What to Do When You Get a "MEMORY FULL" Message while Making Copies	9-2
Chapter 10.	❖ PRINTING REPORTS AND LISTS	10-1
	Activity Report Interval	10-2
	Printing the All Dial List	10-3
	Transmission Verification (Xmit) Report	10-4
	Memory Status List (Only for FAX-715M/725M)	10-5
Chapter 11.	❖ REGULAR MAINTENANCE AND TROUBLESHOOTING	11-1
	Cleaning	11-1
	Paper Jams	11-2
	Fixing a Document Jam	11-2
	Fixing a Cutter Jam or Printer Jam	11-3
	Troubleshooting	11-4
	Error Messages	11-4
	Other Problems	11-5
Chapter 12.	❖ IMPORTANT INFORMATION	12-1
	Standard Telephone and FCC Notices (Applies only to 120V model)	12-1
	Important Safety Instructions	12-2

CONTENTS

<i>Chapter 13.</i>	❖ INDEX	13-1
<i>Chapter 14.</i>	❖ SPECIFICATIONS	14-1

1. SETUP & PREPARATION BEFORE USE

Common Misunderstandings about Fax Machines

This section is for people who are using a fax machine for the first time. Its purpose is to take away the mystery. Once you understand the meaning of the new tones you will be hearing on your phone line, you will be able to send and receive faxes with ease. This will help you troubleshoot an occasional problem with a fax transmission, by listening through your one-way speaker to discover the problem.

What Are Fax Tones?

First the sending machine sends CNG tones, soft intermittent beeps at 4 second intervals. You will hear them when you dial and press the START key. CNG stands for “calling” tones. They continue for 30 seconds after dialing; during that time the sending machine must begin the “handshake” with the receiving machine. Each time you send an “automatic” fax transmission, you are sending calling tones over the phone line. Learn to listen for these soft beeps each time you answer a phone on your fax line so you will know if you are receiving a fax message.

Then the receiving machine responds with fax receiving tones, loud chirping sounds. When a machine begins the receiving mode cycle, it will chirp for 40 seconds over the phone line. At the same time, the fax machine’s display screen will say “receiving”. If you set your machine to AUTO answer mode for a dedicated fax line, it will answer every call automatically with fax receiving tones. Sometimes people will call your fax line by mistake and hang up when they hear the shrill chirping sounds. Your machine is not malfunctioning when it continues to say “receiving”; it must complete its 40 second cycle, even though the call was not a fax message and the caller hung up. To take your machine out of receiving mode, press the STOP key.

The fax machine answers with a short beep when it answers in F/T mode. This can not be changed. After the beep the fax machine listens for CNG tones. When it hears CNG tones, it responds with receiving tones.

Why Does the Ring Change in F/T Mode?

When a double-ring (short, short) occurs after the normal long rings in the Fax/Tel Switch (F/T mode), it means your fax machine is telling you to take over a call. The fax machine has answered either a telephone call or a manual fax (no calling tones). When you hear the double-ring, **pick up any extension phone or the handset of your fax machine.**

SETUP & PREPARATION BEFORE USE

What is the Fax “Handshake”?

The calling machine sends CNG tones (beeps) and the receiving machine sends receiving tones (chirps). During the handshake these tones must overlap for 2-4 seconds so the fax machines can set up protocol. The sending machine states how it is sending the message; the receiving machine answers whether it is capable of receiving that way. The sending machine's CNG tones continue for only 30 seconds after the number is dialed. Calls must be answered within 4 rings (20-22 seconds) or less, because the handshake can not begin until the call is answered. With 4 rings, only 8-10 seconds are left for the fax machines to hear their tones clearly and communicate. **Timing is crucial.**

When you have a telephone answering device (TAD) on your fax line, you can set the TAD to answer in 4 rings as long as you record a 5 second silence as the beginning of your OGM (outgoing message) (See page 7-10 for more information). This will prevent the OGM from covering up the fax tones during the 8 seconds that are left for the handshake. As soon as your TAD answers a call, your fax machine will listen for fax tones for 30 seconds. So you must limit your speaking to 20 seconds (25 second total OGM). Since many people dial manually without realizing they are not sending fax tones, you should give your Remote Activation Code (*51) as the last part of your 20 second Message. For example: “After the beep, either leave a message or send a fax by pressing *51.” (See page 7-10 for more information.)

What Causes the Transmission Verification Report to Print “Result: NG”?

During the handshake, the document(s) you are sending begin to roll through the feeder and stop until the handshake is completed and the machines are ready to send and receive the data. If there is noise or static on the phone line or if the machines do not agree on protocol, they drop their baud rate to the next lower level and try again. The initial baud rate is 14400, then 12000 (Only for FAX-725M), 9600, 7200, 4800 and finally 2400. Transmissions as low as 2400 baud can be successful. So, do not stop your machine. If the transmission fails, a Transmission Verification Report will be printed automatically with “Result: NG”. This usually means the transmission was “No Good” because of temporary noise or static on the phone line. Try to send the fax again. Also, you may try sending a fax to other locations to see if the problem is on the phone line at your end.

Is This a Fax Call?

There are three signs that the call you answered is a fax. You will hear either soft intermittent beeps (Automatic transmission), silence (Manual transmission) or the voice of someone telling you he/she is trying to send you a fax (Manual transmission). **Do not hang up the handset.** It is very frustrating for the person who hears you repeatedly answer and hang up. People who dial manually are waiting to hear fax tones before pressing START. You must activate your fax machine to take over the call before you disconnect the line by replacing the handset.

How Can I Send the Call to My Fax Machine?

When you answer a call that is a fax transmission, you must activate your fax machine to go into fax receiving tones (chirping) before you hang up. If you have answered the fax handset, press the **START** key and hang up immediately. If you are on another phone, there is no **START** key so you must press your three-digit **Remote Activation Code**. The factory default setting is ***51**. Press the code **quickly and wait** to hear your fax machine chirp through the handset. It takes 3 seconds for the fax to respond. You can press the code as many times as needed.

What is the Difference Between Automatic and Manual Transmission?

Automatic transmission is the easiest way to send a fax. Simply place the document(s) face down in the feeder, dial the phone number and press the **START** key immediately. **Do not pick up the handset or press the HOOK key.** Calling tones will go over the phone line.

Manual transmission occurs when you start with a dial tone before you dial, by lifting the handset or pressing the **HOOK** key. You will hear the rings on the phone line. You must wait to hear the receiving machine answer with a chirp before you press the **START** key. If you wait too long to press **START** without a document in the feeder, your fax machine will go into receiving mode instead of sending and you will see "receiving" on the screen.

What is the Difference Between Automatic and Manual Dialing?

Automatic dialing is when you dial by pressing the keys where you stored a number. Your fax machine stores two kinds of automatic dialing numbers: **One-Touch** and **Speed-Dial**. Reserve your most frequently dialed numbers (and Groups) for your One-Touch keys; all you have to do is press the One-Touch key followed by the **START** key (2 key strokes). To use a Speed-Dial number, press the Speed-Dial key and the two-digit code you used to store the number, followed by the **START** key (4 key strokes). You can dial automatically using One-Touch and Speed-Dial numbers for both automatic and manual transmissions.

Manual dialing is simply pressing all the digits of the phone number. You can dial manually for both automatic and manual transmissions.

What Should I Do If My Fax Machine Does Not Have a Dial Tone?

There are three jacks in the back of the fax machine: **LINE**, **EXT** and **PC I/F**. Double-check that the telephone line cord is plugged into the **LINE** jack and not into **EXT** or **PC I/F**. (Plugging the telephone line cord into the **EXT** or **PC I/F** jack is the most common cause of no dial tone.)

If the telephone line cord is plugged into the **LINE** jack of the fax machine and you do not get a dial tone, test the phone line. Go to another phone and check for a dial tone; then bring that working telephone and cord and plug them into the wall jack for your fax machine. If you do not get a dial tone with the working phone, the problem is the phone line. Call the Telephone Company and report the problem.

Choosing a Suitable Place for Your Fax Machine

Use the following list as a guide to find a suitable place for your fax machine.

The Good Places...

Place your fax machine on a flat, stable surface, such as a desk.

Select a place that is free of vibration and shocks.

Locate it near a telephone jack and a standard, grounded power outlet.

And the Bad Places...

Avoid setting it up in a high-traffic area.

Avoid setting up the machine near heaters, air conditioners, water, chemicals, or refrigerators.

Do not select a place that exposes your fax machine to direct sunlight, excessive heat, moisture, or dust.

Do not connect your fax machine to electrical outlets controlled by wall switches or automatic timers. Disruption of power can wipe out information in the unit's memory.

Do not connect your fax machine to electrical outlets on the same circuit as large appliances or other equipment that might disturb the power supply.

Avoid interference sources, such as speakers or the base units of cordless phones.

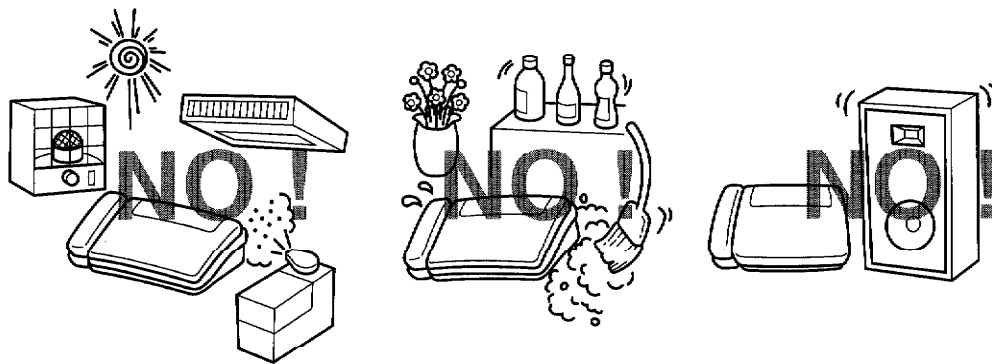

Packing List

Please check to see that you have the following items:

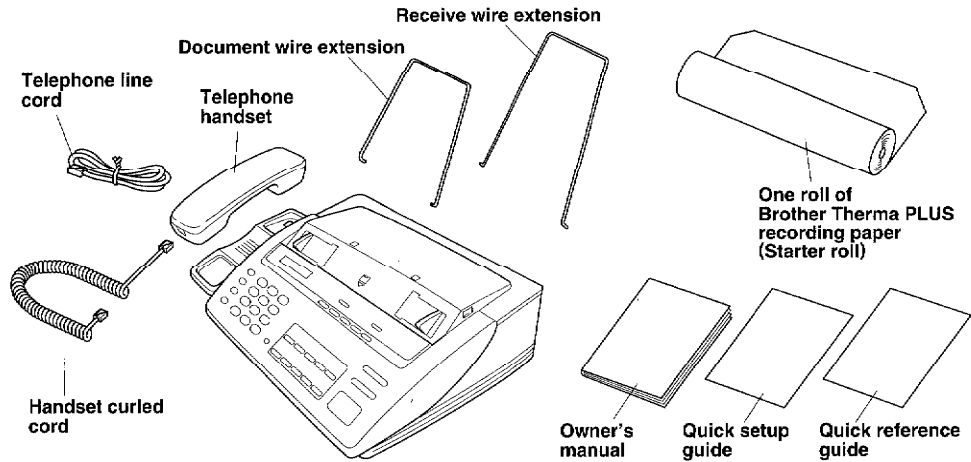

Setting up Your Fax Machine

Follow these steps to set up your fax machine:

1. Load the recording paper.

- 1) Lift up the machine's top cover by placing your finger in the grooves on both sides of the fax machine and lifting up.
- 2) Pull the release lever (blue) on the print head unit so that you can lift it up and remove the recording paper.
- 3) Take the new roll of recording paper out of its wrapper. If you are replacing a roll, you must remove any paper remaining in the machine.
- 4) Insert the new recording paper into the paper bin, **with the paper coming under the top of the roll.**
- 5) Insert the edge of the paper into the slot between the roller and the plate marked with "▲". Pull and hold the paper out about 4 inches (10cm) from the back side. Adjust the recording paper so that it is between the marks.

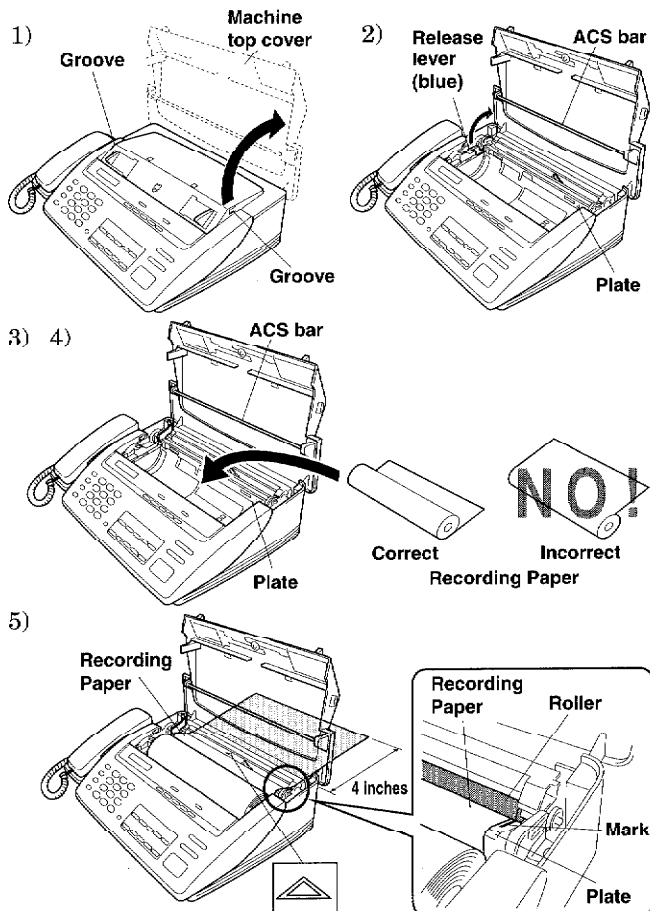

SETUP & PREPARATION BEFORE USE

6) Push the release lever (blue) down, then close the machine top cover.

2. Connect the handset.

3. Connect the power cord.

When you connect the power, your fax machine will cut the fax paper automatically, and the display will read: "01/01/1996 00:00".

NOTICE

1. This fax machine must be grounded using a 3-prong plug.
2. Since the machine is grounded through the power outlet, you can protect yourself from potentially hazardous electrical conditions on the telephone network by keeping the power to your fax machine on when you connect it to a telephone line. Similarly, you can protect yourself when you want to move your machine, by disconnecting the telephone line first, and then the power cord.
3. Lightning and Power Surges can damage this product! We recommend that you use a quality Surge Protection Device on the AC power line as well as the telephone line or unplug the lines during a lightning storm.

4. Connect the telephone line.

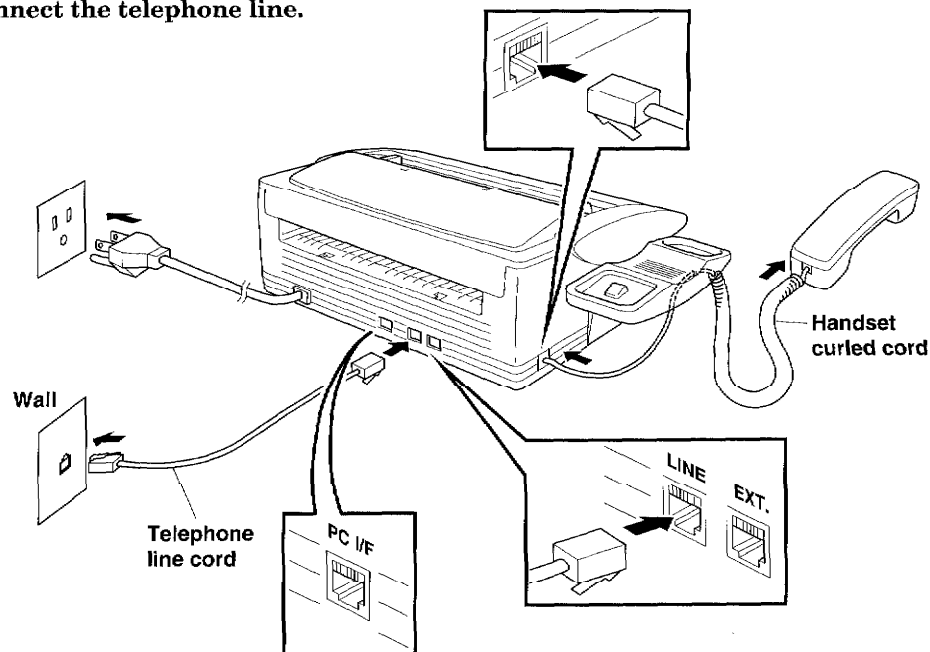

* PC I/F jack is only for use with the Brother Missing Link option. If you have not purchased this option then ignore this part.

5. Attach the wire extensions.

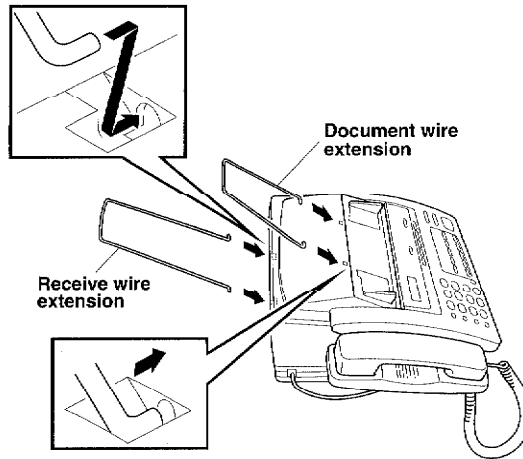

FOR YOUR INFORMATION

Roll Over Phone Lines

A roll over phone system is a group of two or more separate telephone lines that pass incoming calls to each other if they are busy. The calls are usually passed down or “rolled over” to the next available phone line in a preset order.

Your fax machine can work in a roll over system as long as it is the last number in the sequence so the call can not roll away. Do not put the fax machine on any of the other numbers. When the other lines are busy and a second fax call is received, the fax call is transferred to a line that does not have a fax machine.

Two Line Phone System

A two line phone system is nothing more than two separate phone numbers on the same wall outlet. The two phone numbers can be on separate jacks (RJ11) or combined into one jack (RJ14). Your fax machine must be plugged into an RJ11 jack. RJ11 and RJ14 jacks may be equal in size and appearance and both may contain 4 wires (black, red, green, yellow). To test the type of jack, plug in a two line phone and see if it can access both lines. If it can, you must separate the lines for your fax machine.

Converting Telephone Wall Outlets

There are three ways to convert to an RJ11 receptacle. The first two ways may require assistance from the telephone company. You can change the wall outlet from one RJ14 jack to two RJ11 jacks. Or, you can have an RJ11 wall outlet installed and slave or jump one of the phone numbers to it. The third way is the easiest. Buy a triplex adapter.

FOR YOUR INFORMATION

You can plug a triplex adapter into an RJ14 wall outlet. It will separate the wires into two separate RJ11 jacks (line 1, line 2) and a third RJ14 jack (lines 1 and 2). Plug the fax machine into L2 of the triplex adapter.

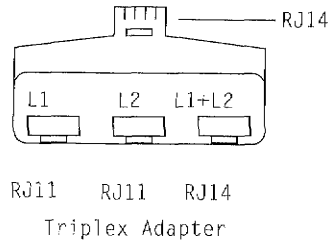

Installing a Fax Machine, Two Line TAD and Two Line Telephone

When you are installing a two line telephone answering device (TAD) and a two line telephone, your fax machine must be isolated on one line at both the wall jack and at the TAD. The most common connection is to put the fax machine on line 2. The back of the two line TAD must have two telephone jacks: one labeled L1 or L1 and L2 and the other labeled L2. You will need at least three telephone line cords: the one that came with your fax machine and two for your two line TAD. You will need a fourth line cord if you add a two line telephone.

Place the two line TAD and two line telephone beside your fax machine. Plug one end of the telephone line cord for your fax machine into the L2 jack of the triplex adapter; plug the other end into the LINE jack in the back of the fax machine. Plug one end of the first telephone line cord for your TAD into the L1 jack of the triplex adapter; plug the other end into the L1 or L1 and L2 jack in the back of the two line TAD. Plug one end of the second telephone line cord for your TAD into the L2 jack in the back of the two line TAD; plug the other end into the EXT jack in the back of the fax machine. The two line TAD hookup is complete. It will answer both lines as usual.

You can keep two line telephones on other wall outlets as always. There are two ways to add a two line telephone to the fax machine's wall outlet. Plug the telephone line cord from the two line telephone into the L1+L2 jack of the triplex adapter. If you prefer, you can plug it into the TELE jack in the back of the two line TAD instead.

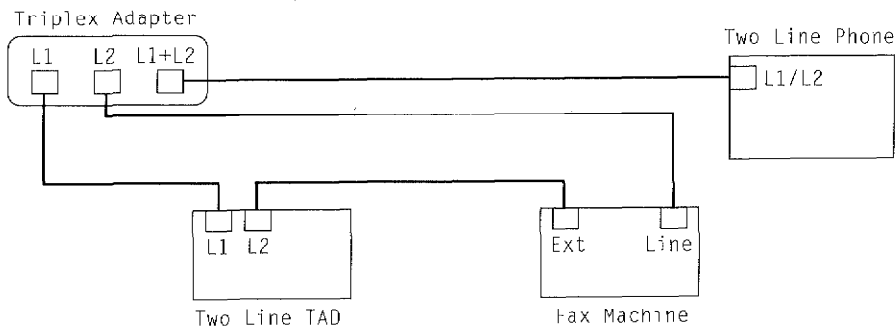

FOR YOUR INFORMATION

Multi Line Connections (PBXs)

Most offices use a central telephone system. While it is often relatively simple to connect the machine to a key system or a PBX (private branch exchange), we suggest that you contact the company that installed your telephone system and ask them to connect the fax machine for you.

It is advisable to have a separate line for the fax machine. You can then leave the machine in AUTO Answer Mode to receive faxes at any time of the day or night.

If the fax machine is to be connected to a multi-line system, ask your installer to connect the unit to the last line on the system. This will prevent the unit from being activated each time a telephone call is received.

- As with all fax units this machine must be connected to a two wire system. If your line has more than two wires, proper connection of the fax machine can not be made.

Connecting to a Private Branch Exchange

The following points should be kept in mind if you are installing the machine to work with a private branch exchange (PBX).

- 1) It is not guaranteed that the unit will operate correctly under all circumstances with PBXs. Any cases of difficulty should be reported first to the company that handles your PBX.
- 2) If all incoming calls will be answered by a switchboard operator, it is recommended that the Answer Mode be set to be MANUAL. (See page 7-2.) All incoming calls should initially be regarded as telephone calls.
- 3) The unit may be used with either the pulse or tone dialing telephone types.

Custom Features on Your Phone Line

If you have Call Waiting, Ring Master, Voice Mail, an Answering Service, Alarm System or any other custom feature on your telephone line it may create a problem in the operation of your fax machine.

2. THE CONTROL PANEL KEYS

FAX-615

Ⓐ TELEPHONE AREA

Ⓒ FUNCTION AND USER SETTING AREA

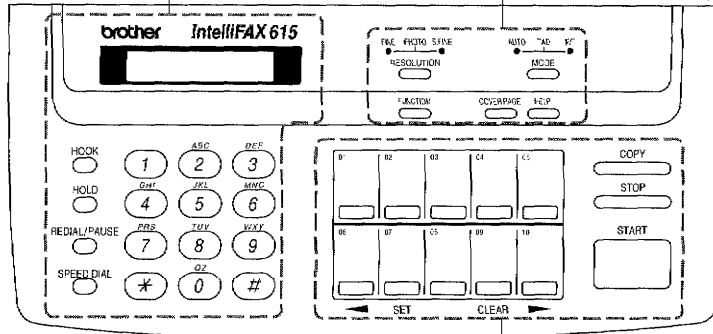

Ⓑ ONE-TOUCH AREA

FAX-675 (FAX-625 and 635 panel keys are same as 675.)

Ⓐ TELEPHONE AREA

Ⓒ FUNCTION AND USER SETTING AREA

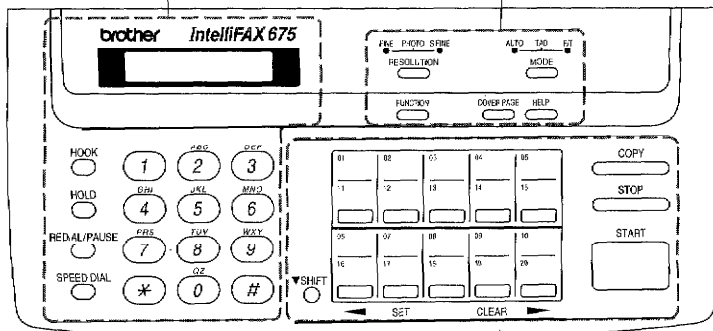

Ⓑ ONE-TOUCH AREA

FAX-725M (FAX-715M panel keys are same as 725M.)

Ⓐ TELEPHONE AREA

Ⓒ FUNCTION AND USER SETTING AREA

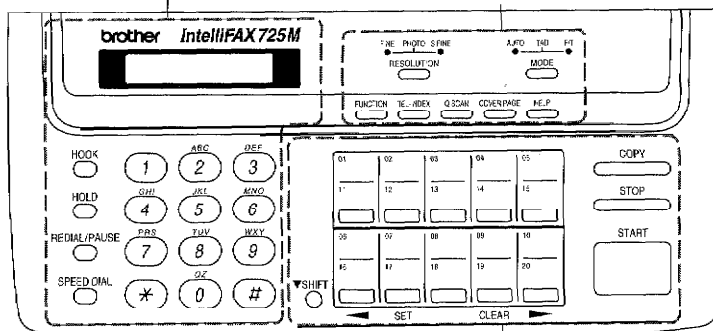

Ⓑ ONE-TOUCH AREA

A TELEPHONE AREA

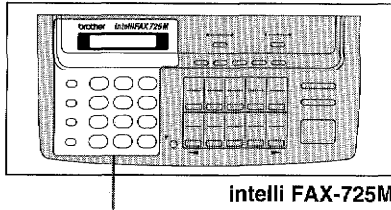

1. Liquid Crystal Display

The LCD displays messages that will help you set up and operate your fax machine. (On-Screen Programming) (See page 3-1.)

2. Number Keys

These twelve keys are used to dial phone and fax numbers (see page 5-1), and can also be used as an alphanumeric keyboard for entering information into the fax machine (see page 3-8~9).

3. HOOK

This key lets you dial telephone and fax numbers without lifting the handset. (See page 5-1.)

4. HOLD

You can use this key to put a call on hold. (See page 5-1.)

5. REDIAL/PAUSE

This key re-dials the last number called. (See page 6-5.) This key is also used to insert a pause in autodial numbers. (See page 4-5, 5-1.)

6. SPEED DIAL

This key lets you access previously stored speed dial phone numbers with a two digit number. (See page 4-6, 5-1.)

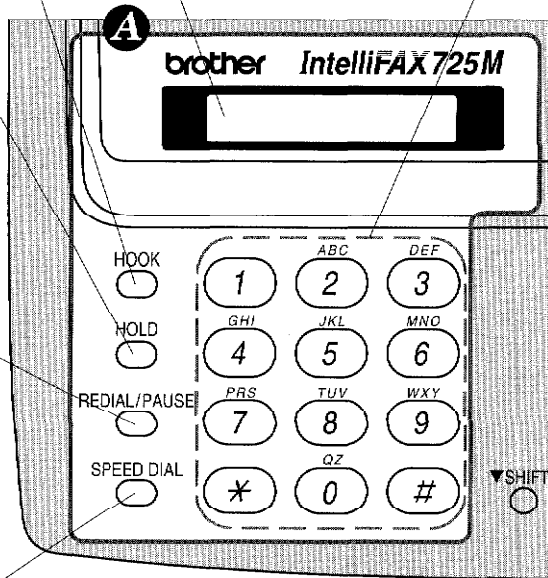

B ONE-TOUCH AREA

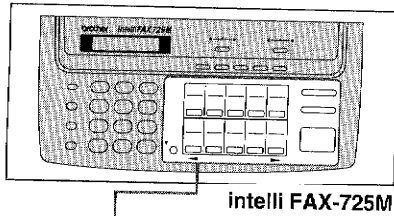

intelli FAX-725M

7. One-Touch Dial Keys

These ten keys give you instant access to previously stored phone numbers. (See page 4-4, 5-1.)

9. ◀ (Left Arrow)*

This key moves the LCD cursor to the left. It also allows you to back up one step when you are in function mode (see page 3-1) or Telephone Index. (Only for FAX-715M/725M.)

11. SHIFT**

This key is used to access the "11" through "20" One-Touch keys. (See page 4-4.)

12. SET*

This key is used for storing a function setting into the fax machine. (See page 3-2.)

14. CLEAR*

This key deletes entered data or backs up one step in a function procedure. (See page 3-2.)

8. COPY

Press this key to make a copy. (See page 9-1.)

10. STOP

This key stops a fax, cancels an operation, or exits from function mode. (See page 3-2.)

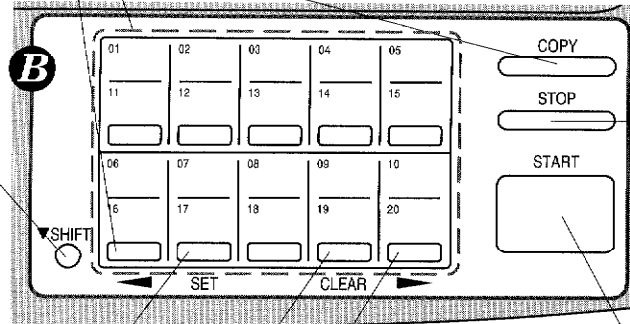

13. START

Use this key to start an operation, such as sending a fax. (See page 6-4.)

15. ▶ (Right Arrow)*

This key moves the LCD cursor to the right, and it also lets you advance one step when you are in function mode (see page 3-1) or Telephone Index. (Only for FAX-715M/725M.)

* The Left and Right Arrow keys, SET and CLEAR keys are also shared with one-touch keys.
 ** The SHIFT key is not available on the FAX-615.

⑥ FUNCTION AND USER SETTING AREA

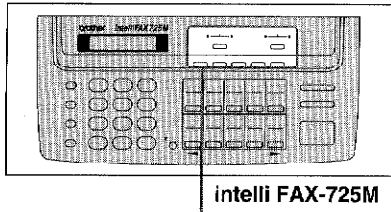

16. FUNCTION

This key accesses the function and programming mode (OSP), so you can alter various settings. (See page 3-1.)

18. TEL-INDEX*

This key allows you to alphabetically look up numbers stored in the dialing memory. (See page 5-2.)

17. RESOLUTION

This key is used to set the resolution requirements when sending a fax. (See page 6-2.)

19. MODE

This key is used to specify how the fax machine should handle incoming calls. (See page 7-1.)

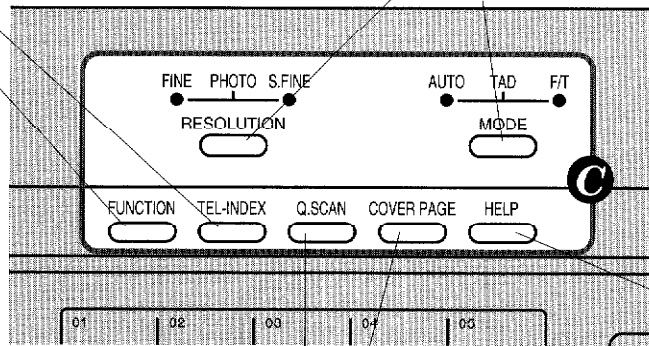

20. QUICKSCAN*

This key enables you to scan in your originals at twice the normal speed, by storing them in the memory before actual transmission. (See page 6-6.) When it is pressed, Broadcasting is available. (See page 6-8.) When it is pressed together with SHIFT, Multi TX is available. (Only for FAX-715M/725M.) (See page 6-9.)

21. HELP

Press this key whenever you want a quick reference Help List printed. This Help List will give you information on how to perform settings for a function, how to register information, or how to get some basic information for sending or receiving faxes. (See page 3-6~7.)

22. COVER PAGE

This key is used to send an automatic Cover Page as the first page of a fax transmission. (See page 6-14.)

* The TEL-INDEX and QUICKSCAN keys are not available on the FAX-615/625/635/675.

3. HOW TO USE ON-SCREEN PROGRAMMING (OSP) AND HELP KEY

User-friendly Programming

We have designed your fax machine with on-screen programming and a **HELP** key, user-friendly programming that helps you take full advantage of all the functions your fax machine has to offer.

On-screen Programming (OSP)

Since your fax programming is done on the LCD, we created step-by-step on-screen prompt messages to help you program your fax machine. All you need to do is follow the prompt instructions as they guide you through the function menu selections and programming options and settings.

Using the Function Mode to Access On-screen Programming (OSP)

You can access the function mode by pressing **FUNCTION** found in the "Function and User Setting Area" of your fax Control Panel. (See page 2-4.)

When you enter function mode, your fax machine will display a list of Level One Functions to choose from (see pages 3-2 through 3-5 for these Level One Functions), as seen below.

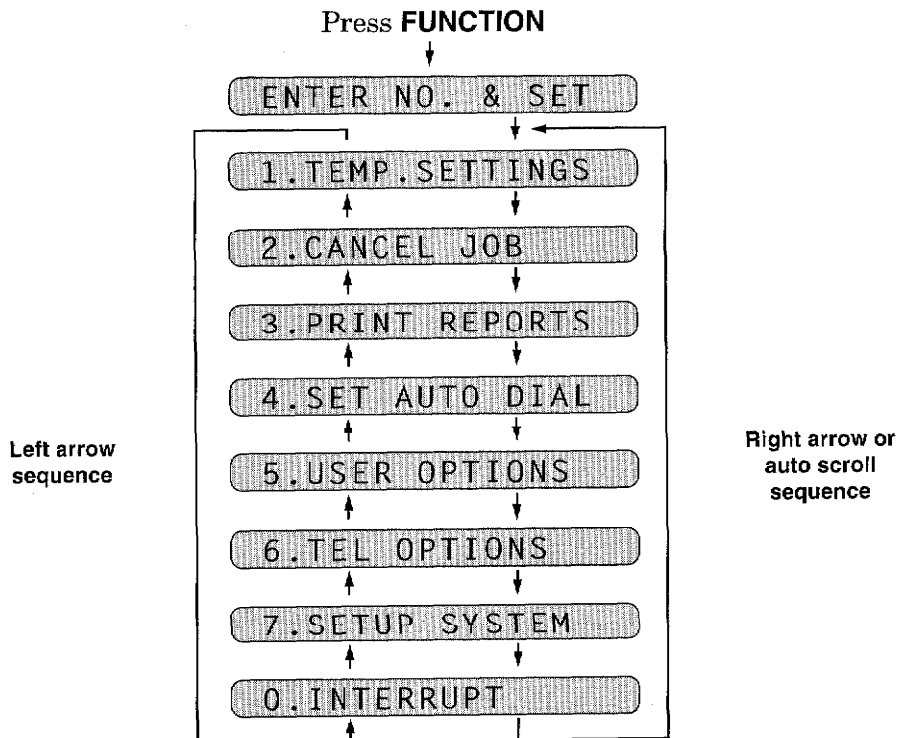

HOW TO USE ON-SCREEN PROGRAMMING AND HELP KEY

These function options will appear one after the other on the display. You can then choose one of these options by pressing **SET** when the option you want appears on the LCD.

You can also move through the function menu options at a faster rate by pressing **▶** (right arrow). (See page 2-3 to locate this key on your Control Panel.) When you find the option you want, press **SET**.

You can simply press the Level One Function number associated with each option (refer to pages 3-2 through 3-5).

Helpful Hints If you want to exit function mode, simply press **STOP**. Also, if you select the wrong menu, and wish to return to the previous step, press **CLEAR**.

Alternating Displays for On-screen Programming (OSP)



When you see alternating displays, the LCD will usually alternate between the currently selected option, and a help message giving brief instructions on how to proceed. The example shows the current speaker volume is high and prompts you to use **◀** (left arrow) and **▶** (right arrow) to change the setting, and then to press **SET** to store it.

Function Selection Table

If you have a basic understanding of how to program a fax machine, you can perform most of the programming settings without the owner's manual. To help you understand the function selections, options, and settings that are found in your fax programs, we have the following Function Selection Table.

Read through this table to gain a basic understanding of what your new fax model can do, and then the next section will begin instructing you how to use on-screen programming.

Level one function	Level two function	Explanation of Options	Factory setting	Page
1. TEMP. (TEMPORARY) SETTINGS	1. TIMER	Use this for sending documents at a later time.	—	6-7
	2. POLLING	Polling is the process of retrieving faxes from another machine. You can also choose if you want your polling secured. STANDARD/SECURE	STAN- DARD	8-1~5
	3. CALL RESERVE	You can send a fax and then talk to the recipient using the CALL RESERVE function. ON/OFF	OFF	6-18~19

HOW TO USE ON-SCREEN PROGRAMMING AND HELP KEY

Level one function	Level two function	Explanation of Options	Factory setting	Page
1. TEMP. (TEMPORARY) SETTINGS	4. CONTRAST	There are three types of contrast settings. Usually the AUTO setting is acceptable. But if you want to send an especially light or dark document, you should change this setting. AUTO: Default setting is AUTO. Contrast setting always reverts to AUTO after one transmission. S. LIGHT: To send very light documents. S. DARK: To send very dark documents.	AUTO	6-3
	5. RESOLUTION	If you need to send a set of originals at various resolutions, this function will allow you to set the required resolution page by page. (If all documents are the same resolution, use the RESOLUTION key. See page 2-4 #17.) STANDARD/FINE/S. FINE/PHOTO	STANDARD	6-12~13
	6. OVERSEAS MODE	If you have trouble when sending overseas, you may want to set OVERSEAS MODE to ON. ON/OFF	OFF	6-12
2. CANCEL JOB		If you wish to cancel a job that has been set with the timer, a polled job etc., use this function.		6-11
3. PRINT REPORTS	See page 10-1 for a list of reports.	You can print several different lists and reports, which are available under function item 3. PRINT REPORTS.		10-1~5
4. SET AUTO DIAL	1. ONE-TOUCH DIAL	If you register names and numbers on One-Touch dial keys, you can dial a number automatically just by pressing a One-Touch key. (Max. of 10 locations for FAX-615 and 20 locations for other models.)	—	4-4~5
	2. SPEED-DIAL	If you register names and numbers as Speed-Dial numbers, you can dial a number automatically just by pressing SPEED DIAL and a two-digit number. (Max. of 20 locations for FAX-625 and 30 locations for FAX-615/635 and 40 locations for FAX-675/715M/725M.)	—	4-6~7
	3. SETUP GROUPS (Only for FAX-715M/725M)	This is used for setting up a group number used for broadcasting.	—	4-8~9

HOW TO USE ON-SCREEN PROGRAMMING AND HELP KEY

Level one function	Level two function	Explanation of Options	Factory setting	Page
5. USER OPTIONS	1. SMOOTHING	Smoothing enhances the appearance of incoming faxes. If you set SMOOTHING to ON, you will receive messages with the smoothing enhancement. ON/OFF	ON	7-4
	2. BEEPER	You can adjust the volume of the beeper with this function. OFF/LOW/HIGH	LOW	4-1~2
	3. COVERPG ON/OFF	If you set COVERPAGE to ON, you can send your documents with a Cover Page generated by your machine. When the COVERPAGE setting is ON, you can select a Cover Page comment. ON/OFF	OFF	6-16
	4. GRAY SCALE (Only for FAX-615/625)	You can select a GRAY SCALE level. FAX-635/675/715M/725M have a fixed gray scale of 64. 16/32	32	6-13
	4. ERROR RE-TX (Only for FAX-715M/725M)	If you set ERROR RE-TRANSMISSION to ON, the machine automatically resends the page once an error occurs. ON/OFF	OFF	6-20
6. TEL OPTIONS	1. TONE/PULSE	There are two different dial types and you must select the type of signal suitable for your telephone line. TONE/PULSE	TONE	4-1
	2. RING DELAY	This is the number of rings before the fax machine answers the call when in F/T or AUTO Answer Mode. 0/1/2/3/4 rings	2	7-2
	3. SPEAKER VOLUME	You can adjust the speaker volume with this function. OFF/LOW/HIGH	LOW	7-5
	4. F/T RING TIME	F/T RING TIME sets the time for simulated ringing in F/T mode. 10/20/30/60 seconds	20	7-4
	5. RING VOLUME	The settings are OFF/LOW/HIGH.	HIGH	7-5

HOW TO USE ON-SCREEN PROGRAMMING AND HELP KEY

Level one function	Level two function	Explanation of Options	Factory setting	Page
6. TEL OPTIONS	6. DISTINCTIVE	If you have distinctive ringing service from your phone company, you can use this function to register the ringing pattern of your fax number. And if you set it to ON, you can use the registered number as a fax number only. ON/SET/OFF	OFF	7-12-15
	7. CALLER ID (Only for FAX-715M/725M)	You can display the last 30 Caller IDs that are stored in the memory.	—	7-16-19
7. SETUP SYSTEM	1. DATE/TIME	If you enter the date and time in 24-hour format, the LCD will display the date and time and they will also be printed on outgoing faxes.	000 01/01/1996	4-2
	2. DAILY TIMER	If you frequently have delayed jobs, all for execution at the same time each day, you can program that time. Once you register it, you do not need to enter that time, just set Timer Transmission in temporary settings.	00:00	6-7-8
	3. INTERVAL	You can select the time interval when the activity report will be printed. 6/12/24 hours, 2/4/7 days, OFF	OFF	10-2
	4. STATION ID	You can enter your name or company name, fax number and telephone number in STATION ID. It is printed at the top of each page of every outgoing fax. It is also printed on the automatic Cover Page.	—	4-3
	5. REMOTE CODE	If you enter a REMOTE CODE, you can activate or deactivate the fax machine from a remote telephone. ON/SET CODE/OFF	ON *51 (ACT.) #51 (DEACT.)	7-7-9
	6. SET COVERPAGE (Only for FAX-715M/725M)	You can register your own two custom comments for the Cover Page.	—	6-15
0. INTERRUPT	—	You can send a fax without canceling the timer or polled waiting, even if there are documents in the feeder, by "interrupting" it.	—	6-10

Help Key

Press this key whenever you need a quick reference Help List printed. This Help List will give you information on how to perform settings for a function, how to register information, or how to get some basic information for sending or receiving faxes.

How to print a Help List

Press **HELP** to get a printout of the Help List. Use it when you need information about how to register or set one of the functions, or how to send or receive faxes. You can request a printout whenever the machine meets the following conditions:

- while the LCD displays the date and time.
- while the machine is timer waiting.
- while the machine is polled/polling waiting.
- while the machine is at level one or two of the function menu.
- while you are using the phone.

HOW TO USE ON-SCREEN PROGRAMMING AND HELP KEY

***** HELP LIST *****

<STEPS FOR KEY FUNCTIONS>

- 1) PRESS FUNCTION
- 2) SELECT A LEVEL ONE FUNCTION BY PRESSING NUMBER KEY (FROM THE SELECTION CHART ON THE RIGHT)
- 3) SELECT A LEVEL TWO FUNCTION BY PRESSING NUMBER KEY
- 4) SELECT THE DESIRED SETTING USING THE ARROW KEYS
 ← →
- 5) PRESS SET
- 6) PRESS STOP TO EXIT

NOTE:
MAKE SURE YOU FIRST SET TONE/PULSE(FUNCTION 6-1), DATE/TIME(FUNCTION 7-1) AND STATION ID(FUNCTION 7-4).

<FUNCTION SELECTION CHART>

<p>LEVEL ONE</p> <p>1. TEMP. SETTINGS---</p> <p>2. CANCEL JOB</p> <p>3. PRINT REPORTS---</p> <p>4. SET AUTO DIAL---</p> <p>5. USER OPTIONS ---</p> <p>6. TEL OPTIONS ---</p> <p>7. SETUP SYSTEM ---</p> <p>0. INTERRUPT</p>	<p>LEVEL TWO</p> <p>1. TIMER</p> <p>2. POLLING (STANDARD/SECURE)</p> <p>3. CALL RESERVE (ON/OFF)</p> <p>4. CONTRAST (AUTO/S. LIGHT/S. DARK)</p> <p>5. RESOLUTION (STD/FINE/S. FINE/PHOTO)</p> <p>6. OVERSEAS MODE (ON/OFF)</p> <p>1. ACT. REPORT</p> <p>2. ALL DIAL</p> <p>3. TEL. INDEX</p> <p>4. COVERPAGE</p> <p>5. CALL BACK MSG</p> <p>6. USER OPTIONS (ON/OFF)</p> <p>7. XMIT REPORT</p> <p>8. MEMORY STATUS</p> <p>9. CALLER ID</p> <p>1. ONE-TOUCH DIAL</p> <p>2. SPEED-DIAL</p> <p>3. SETUP GROUPS</p> <p>1. SMOOTHING (ON/OFF)</p> <p>2. BEEPER (OFF/LOW/HIGH)</p> <p>3. COVERPG ON/OFF (ON/OFF)</p> <p>4. ERROR RE-TX (ON/OFF)</p> <p>1. TONE/PULSE (TONE/PULSE)</p> <p>2. RING DELAY (00/01/02/03/04)</p> <p>3. SPEAKER VOLUME (OFF/LOW/HIGH)</p> <p>4. F/T RING TIME (10/20/30/60)</p> <p>5. RING VOLUME (OFF/LOW/HIGH)</p> <p>6. DISTINCTIVE (OFF/ON/SET)</p> <p>7. CALLER ID</p> <p>1. DATE/TIME</p> <p>2. DAILY TIMER</p> <p>3. INTERVAL (OFF/6H/12H/24H/2D/4D/7D)</p> <p>4. STATION ID (FAX/TEL/NAME)</p> <p>5. REMOTE CODE (ON/OFF,SET CODE)</p> <p>6. SET COVERPAGE</p>	<p>OPTIONS</p>
---	--	----------------

***** EXAMPLE *****

<STORING ONE-TOUCH>

FJUNCTION → ④ → ① → → → → → → →

ONE-TOUCH NUMBER KEYS ALPHA KEYS
 TO ENTER PHONE # SE TO ENTER NAME SET

<SENDING A FAX (AUTO)>

INSERT → OR → OR →

NUMBER KEYS ONE-TOUCH SPEED DIAL START
 DOCUMENT TO DIAL OR + TWO DIGITS

<PRINTING A LIST/REPORT>

FUNCTION → ③ → →

NUMBER KEY START
 TO SELECT REPORT TYPE

<FAX RECEPTION SETTINGS>

MANUAL MODE	AUTO MODE	F/T MODE	TAD MODE
*FOR DEDICATED TELEPHONE USE ONLY.	*FOR DEDICATED FAX USE ONLY.	*FOR BOTH FAX AND TELEPHONE.	*WHEN CONNECTING EXTERNAL TELEPHONE ANSWERING DEVICE.

(HELP LIST of FAX-725M)

HOW TO USE ON-SCREEN PROGRAMMING AND HELP KEY

How to Enter Text in Function Mode

Number keys have two or three letters printed above it. The following keys "1", "#", and "*" have no printed letters because they have special characters.

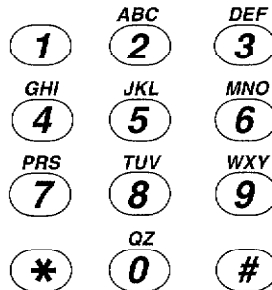

Ch. 3

By pressing the appropriate number key the correct number of times, you can access the character you want. When you are making certain settings, such as the Station ID, you need to enter text into your fax machine.

Key	once	twice	three times	four times
2	A	B	C	2
3	D	E	F	3
4	G	H	I	4
5	J	K	L	5
6	M	N	O	6
7	P	R	S	7
8	T	U	V	8
9	W	X	Y	9
0	Q	Z	0	Q

Let's say that you want to enter the initials "BR." Follow the example below.

KEYS TO PRESS

1. Press **2** twice to enter the letter **B**.
2. Press **7** twice to enter the letter **R**.
3. Press **SET**.

THE DISPLAY WILL SHOW:

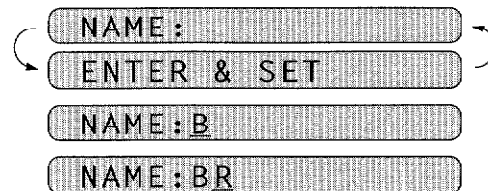

FOR YOUR INFORMATION

1. If you want to enter a blank space, press ► (right arrow) twice.
2. If you entered a letter incorrectly and want to change it, you can use ◀ (left arrow) to move the cursor back. When you reach the letter, you can enter a new one in it's place. You can only overwrite letters, not insert them, so you may have to go back and overwrite a lot of letters if you forget to enter a letter.
3. If you need to enter a character that is assigned to the same number key as the previous character, press ► (right arrow) to move the cursor to the right.

How to Enter Special Characters, Symbols and Punctuation Marks in Function Mode

1 key----- ÄËÖÜÀÇÈÉ1
 * key ----- (space) !"#\$%&'()*+,-./
 # key----- ;<=>?@[]^_

The "1" key contains all the accented characters. The "*" and the "#" key are used for punctuation marks and symbols. Let's say that you want to enter the Symbol "&". Follow the example below.

KEYS TO PRESS

1. Press * to show a list of characters.
2. Press *, *, *, *, *, * (6 times).
3. Press ► (right arrow).

THE DISPLAY WILL SHOW:

NAME: JAMES _

MARK- _!"#\$%&'()**

MARK- !"#\$%&'()**

NAME: JAMES & _

4. TELEPHONE FUNCTION SETTINGS

There are some settings, such as the date and time, you should make to your fax machine before you begin using it. Once entered, these settings will remain in the machine until you change them. You can begin customizing the settings by pressing **FUNCTION** on the control panel. This activates the function mode and On - Screen Programming prompts. You can complete a variety of settings in this mode.

Setting the Dialing Mode (Tone/Pulse)

Your fax machine supports both tone (or multi-frequency) and pulse (or rotary) dialing. It is initially set to **TONE**, so you do not need to change the setting if you use that kind of line. If you are using a pulse dial line, you can change the setting to **PULSE** by following the steps below:

KEYS TO PRESS

1. Press **FUNCTION**.
You will see scrolling options on the display. You can choose one.
2. Press **6**.
3. Press **1**.
After two seconds you will be automatically prompted to select pulse or tone.
4. Press ◀ (left arrow) or ▶ (right arrow) to find the dialing mode that matches your telephone line.
Example: **PULSE**.
5. Press **SET**.
6. Press **STOP** to return to the date and time.

THE DISPLAY WILL SHOW:

01/01/1996 00:00

1. TEMP. SETTINGS

6. TEL OPTIONS

1. TONE/PULSE

DIALING: TONE

SELECT ◀ ▶ & SET

DIALING: PULSE

1. TONE/PULSE

Setting the Beeper Sound Level

If the beeper setting is **LOW** or **HIGH**, it will "beep" every time you press a key, make an error, or at the end of sending or receiving a fax.

The initial setting on your fax machine for the beeper is **LOW**. If you do not want the beeper on, select **OFF**, and if you want it loud, select **HIGH**.

TELEPHONE FUNCTION SETTINGS

KEYS TO PRESS

1. Press **FUNCTION**.
2. Press **5**.
3. Press **2**.
4. Press ◀ (left arrow) or ▶ (right arrow) until you get the setting you want.
Example: OFF.
5. Press **SET**.
6. Press **STOP** to return to the date and time.

THE DISPLAY WILL SHOW:

01/01/1996 00:00

1. TEMP. SETTINGS

5. USER OPTIONS

2. BEEPER

BEEPER: LOW

SELECT ◀ ▶ & SET

BEEPER: OFF

2. BEEPER

Setting the Date and Time

Your fax machine shows the date and time on the display and prints it on every fax page you send. You can set the date and time in function mode.

KEYS TO PRESS

1. Press **FUNCTION**.
2. Press **7**.
3. Press **1**.
4. Enter the last two digits of the year.
Example: **96**.
5. Enter two digits for the month.
(JAN = 01, OCT = 10, etc.)
Example: **09**.
6. Enter two digits for the day.
Example: **12**.
7. Enter the time in 24-hour format.
Example: **15:25** (3:25 P.M.).
8. Wait for two seconds.
9. Press **STOP** to exit and view the new date and time.

THE DISPLAY WILL SHOW:

01/01/1996 00:00

1. TEMP. SETTINGS

7. SETUP SYSTEM

1. DATE/TIME

ENTER YEAR: XX

ENTER YEAR: 96

ENTER MONTH: XX

ENTER MONTH: 09

ENTER DAY: XX

ENTER DAY: 12

ENTER TIME: XX:XX

ENTER TIME: 15:25

1. DATE/TIME

09/12/1996 15:25

Setting the Station ID

The Station ID is for identification purposes. Here you can store your name, fax number, and telephone number. Your machine then prints this information on the electronic Cover Page and every fax page you send.

KEYS TO PRESS

1. Press **FUNCTION**.
2. Press **7**.
3. Press **4**.
You will then be prompted to enter your fax number.
4. Enter your fax number (up to 20 digits).
Example: **4155554444**.
5. Press **SET**.
You will now be prompted to enter your telephone number.
6. Enter your telephone number (up to 20 digits).
If your telephone number and fax number share the same line, enter the same number again.
Example: **4155554445**.
7. Press **SET**.
You will be prompted to enter your name or company's name.
8. Enter your name by using the number keys (up to 20 characters).
Example: **BROTHER**.
Refer to the section "How to Enter Text in Function Mode" on pages 3-8.
9. Press **SET** to confirm the entry.
10. Press **STOP** to return to the date and time.

THE DISPLAY WILL SHOW:

09/12/1996 15:25

1. TEMP. SETTINGS

7. SETUP SYSTEM

4. STATION ID

FAX:

ENTER & SET

FAX:4155554444_

TEL:

ENTER & SET

TEL:4155554445

NAME:

ENTER & SET

NAME:BROTHER

4. STATION ID

FOR YOUR INFORMATION

Printing Page Headers

Your fax machine can print a page header on top of every document you send. It is printed on the receiving party's fax paper. It contains the date and time of transmission, your fax number and name (Station ID), and page number. Of course you need to register your Station ID beforehand for that information to be available.

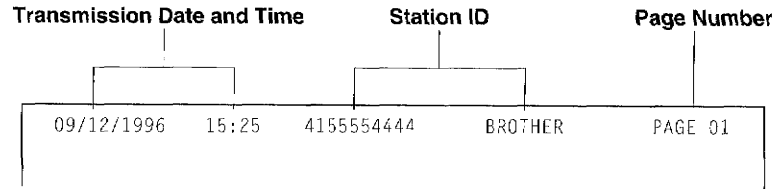

- Helpful Hints**
1. The telephone number that you store is used only for the Call Back Message and the Cover Page features.
 2. If you do not enter a fax number, no additional information can be entered.
 3. When you enter a space, use **▶** (right arrow). Then it will be registered as a blank space.
 4. If Station ID has already been programmed, then after Step 3 the name will be displayed with the prompt "1" to change "2" to exit. Press "1" if you need to change any information. Pressing "2" to exit will take you out of the function.

NOTICE

The Telephone Consumer Protection Act. of 1991 makes it unlawful for any person to use a computer or electronic device to send any message via a telephone fax machine unless such messages clearly contain in a margin at the top or bottom of each transmitted page or on the first page of the transmission, the date and time it is sent and an identification of the business or other entity, or other individual sending the message and the telephone number of the sending machines or such business, other entity, or individual.

In order to program this information into your fax machine, you should complete the steps on the previous page.

Storing One-Touch Dial Numbers

You can dial numbers automatically by storing telephone or fax numbers as One-Touch dial numbers. You can also store names with the numbers so that when you call, you can verify the destination on the display. You can store a maximum of 10 phone numbers for FAX-615 and 20 numbers for FAX-625/635/675/715M/725M. To use 11 to 20 One-Touch number locations, you need to press **SHIFT**. For example, One-Touch location "16" is accessed by pressing **SHIFT**+One-Touch "06" simultaneously (See page 2-3). Here is how to store a telephone number as a One-Touch dial number:

KEYS TO PRESS

1. Press **FUNCTION**.
2. Press **4**.
3. Press **1**.
4. Press the **One-Touch** key you want to use to store a number.
 Example: **One - Touch 05**.
 The One-Touch keys are not the number keys.
5. Enter a number (up to 20 digits).
 Example: **14155551212**.
 NOTE: If you have to wait for a dial tone to access an outside line, you should use **REDIAL/PAUSE**. When you press **REDIAL/PAUSE**, a dash “.” will appear on the display. By storing the numbers with a pause, you can create a delay of 3.5 seconds.
6. Press **SET**.
 You then will be prompted to enter the name or company associated with this number.
7. Enter the name by using the number keys (up to 15 characters).
 Example: **NJ OFFICE**.
 (See page 3-8 for how to enter text.)
8. Press **SET**.
9. Select the type of number (FAX, TEL, F/T, CHAIN) by using ◀ (left arrow) or ▶ (right arrow) to display the type you want.
 (See For Your Information on page 4-6.)
 Example: FAX.
10. Press **SET**.
11. Return to step 4 to enter another number, or press **STOP** to return to the date and time.

THE DISPLAY WILL SHOW:

09/12/1996 15:25

1.TEMP.SETTINGS

4.SET AUTO DIAL

1.ONE-TOUCH DIAL

SELECT ONE-TOUCH

*05:

ENTER & SET

*05:14155551212_

NAME:

ENTER & SET

NAME:NJ OFFICE

TYPE:FAX

SELECT ◀ ▶ & SET

TYPE:FAX

SELECT ONE-TOUCH

FOR YOUR INFORMATION

Types of Numbers

When you store a number as a One-Touch or as a Speed-Dial number, you have a choice of choosing the type of number. There are 4 options:

1. FAX (A fax number).
2. TEL (A telephone number).
3. F/T (Both a fax number and a telephone number)
4. CHAIN (A number, usually an access code, for chain dialing).

Chain Dialing

Chain dialing is used to store a very long dialing sequence. You can spread the number over two or more keys if you register the first key(s) in the sequence as type "Chain". **Chain tells the system that the dialing sequence is not completed and that there is more to follow.** The last key in the sequence must be any other dial type (either FAX, TEL or F/T). You can use any combination of One-Touch, Speed-Dial and manually dialed numbers in a chain.

If you must wait for another dial tone at any point in the dialing sequence, store a pause at that point in the number by pressing the PAUSE/REDIAL key. (If you need a pause that is longer than 3.5 seconds, call our Fax Diagnostic Center at 1-800-284-4329 for assistance.) **Only one pause can be stored in each One-Touch and Speed-Dial number.**

When you are ready to dial the chain number, simply press the keys one after the other in sequence and then press START.

Chain dialing makes using access codes easy. Sometimes you may want to choose from among several long-distance carriers when you make a call; rates may vary depending upon the time and destination. To take advantage of low rates, you can store the access code of a long-distance carrier as you would a regular number and register it as a "chain" number. Then to dial, press this (access code) number followed by the regular number and START.

You can set up chain dialing for phone/credit card numbers, the same way. However, **when using chain dialing, do NOT send a cover page because your credit card number will be on it.**

Storing Speed-Dial Numbers

When you store a phone or fax number as a Speed-Dial number, you must enter a **two-digit number**, from 01 to 20 for FAX-625, from 01 to 30 for FAX-615/635 and from 01 to 40 for FAX-675/715M/725M using the number keys. For example, you cannot enter "5". You need to enter "05". You can store as many as 20 numbers (FAX-625) or 30 numbers (FAX-615/635) or 40 numbers (FAX-675/715M/725M) as Speed-Dial numbers. After you finish entering the numbers, print the All Dial List to check that you have stored them correctly. (See page 10-3.) This list will contain the type of number: FAX, TEL, F/T, or CHAIN.

Even if there should be a loss of electrical power to your fax machine, the telephone and fax numbers you have stored will not be lost.

KEYS TO PRESS

1. Press **FUNCTION**.
2. Press **4**.
3. Press **2**.
4. Use the number keys to enter a two-digit number.
Example: **05**.
5. Enter the number (up to 20 digits).
Example: **5555151**.
6. Press **SET**.
You then will be prompted to enter the name or company associated with this number.
7. Use the number keys to enter a name (up to 15 characters).
Example: **MANCHESTER**.
(See page 3-8-9 for entering text.)
8. Press **SET**.
9. Select the type of number (FAX, TEL, F/T, CHAIN) by using ◀ (left arrow) or ▶ (right arrow) to display the type you want.
Example: TEL.
10. Press **SET**.
11. You are ready to enter another Speed-Dial number, or press **STOP** to return to the date and time.

THE DISPLAY WILL SHOW:

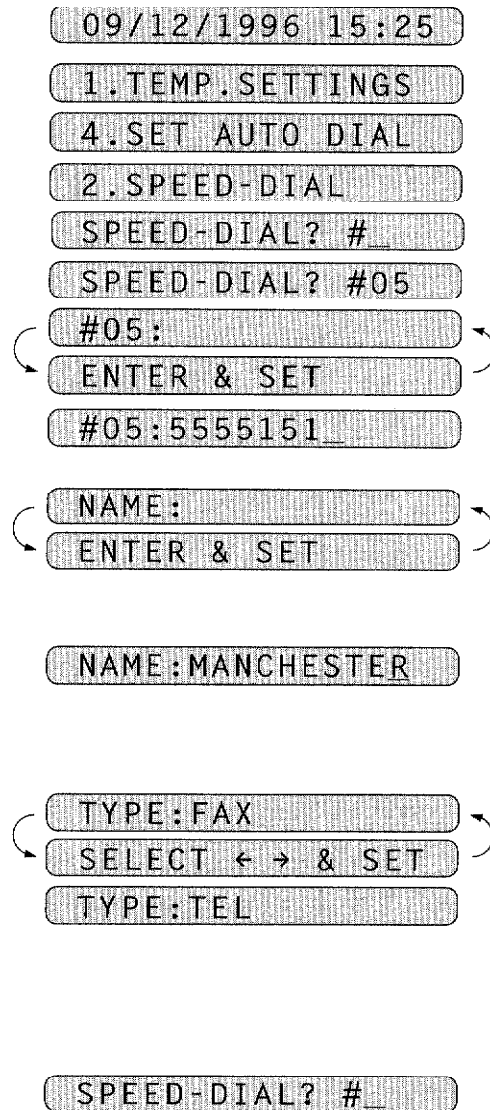

TELEPHONE FUNCTION SETTINGS

FOR YOUR INFORMATION

When You Wish to Change the Stored One-Touch and Speed-Dial Numbers (During Step 4 on Page 4-5, 7)

When you access the function for a One-Touch key or Speed-Dial number, that is already in use, you will be asked if you wish to change it or to exit and select a different One-Touch or Speed-Dial number. This display does not appear if the One-Touch key or Speed Dial number you chose is not assigned.

1. Press **1** to assign a new number to the One-Touch key or Speed-Dial number, or press **2** to choose a different One-Touch key or Speed-Dial number.

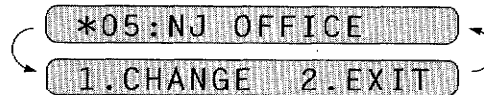

2. If you are replacing an existing number with a new one, the old number and name will appear in the display. Press **CLEAR** to erase the old number and name. Then, enter the new number and name and press **SET** to store the entry.

Memory Storage

Your fax machine is equipped with an internal battery that will keep the date and time information for up to one hour after power has been cut off. After that time, the date and time will be lost and you will have to re-enter the information. All other settings in the **SET AUTO DIAL**, **USER OPTIONS** and **SETUP SYSTEM** functions (see page 3-3~5) are stored permanently and will be retained even in the event of a power failure. However, the data stored in the memory such as **Out-of-Paper Reception** and **Memory Transmission** will be lost after the power is disconnected (only for FAX-715M/725M).

Helpful Hints If your fax machine is connected to a PBX, you may need to insert an additional number before each fax or telephone number to access an outside line.

Setting Up Number Groups (Only for 715M/725M)

Number Groups allow you to send the same fax message to many fax numbers by pressing only one One-Touch key (Broadcasting). You must store each fax number first as a One-Touch or Speed-Dial number. Then you can combine them into a Group. Each Group uses a One-Touch key. You can have up to 6 smaller Groups or can assign up to 59 numbers if you want one large Group. You can use the same stored number in several groups. Groups can have a name up to 15 characters long.

KEYS TO PRESS

1. Press **FUNCTION**.
2. Press **4**.
3. Press **3**.

THE DISPLAY WILL SHOW:

09/12/1996 15:25

1. TEMP. SETTINGS

4. SET AUTO DIAL

3. SETUP GROUPS

SELECT ONE-TOUCH

4. Press one of the One-Touch keys to be the stored group number.
Example: select "One-Touch 1" as a group.

SETUP GROUP:G0
ENTER & SET

5. After two seconds enter the group number by using the number keys.
Example: 1.

SETUP GROUP:G01
G01:
ENTER & SET
G01:#03#05*02

6. Enter the One-Touch or Speed-Dial numbers in this group.
Example: #03, #05, *02.
(Note: Use the # key and number keys for Speed-Dial numbers, and the * key and number keys for One-Touch numbers.)

7. Press **SET**.

NAME:
ENTER & SET
NAME:ALL BROTHER

8. Enter the group's name.
Example: **ALL BROTHER**.

9. Press **SET**.

3.SETUP GROUPS

10. Press **STOP** to return to date and time.

Helpful Hints

You can print a list of all One-Touch numbers and Speed-Dial numbers. Group numbers will be listed under One-Touch and Speed-Dial numbers. (See page 10-3~4.)

* : One-Touch
: Speed-Dial

5. USING THE UNIT AS A TELEPHONE

Your fax machine can be used to make regular telephone calls. You can dial numbers manually, by pressing the number keys, or by using One-Touch or Speed-Dialing.

Manual Dialing

1. Pick up the handset, or press **HOOK**.
2. When you hear a dial tone, you can begin dialing by pressing the number keys.
3. If you used **HOOK** to dial, pick up the handset when the call is answered.

One-Touch Dialing

1. Pick up the handset, or press **HOOK**.
2. When you hear a dial tone, press the desired **One-Touch** key.
3. If you used **HOOK**, pick up the handset when the call is answered.

If you try to use a One-Touch number that has not been stored on the key you pressed, you will hear a warning sound and the display will say, "NOT REGISTERED". The display will return to normal after 2 seconds.

Speed Dialing

1. Pick up the handset or press **HOOK**.
2. When you hear a dial tone, press **SPEED DIAL** and then press the two-digit Speed-Dial number.
3. If you used **HOOK**, pick up the handset when the call is answered.

FOR YOUR INFORMATION

Using HOLD, PAUSE, # with the Telephone

- Use **REDIAL / PAUSE** for putting a 3.5 second pause between numbers.
- Use **HOLD** to put a call on hold. You can put down the handset without disconnecting the call. You must pick up the fax handset to release the call from **HOLD**.
- Use **#** temporarily to switch the dialing type from "pulse" to "tone". This key is also used for push-button services, such as those offered by banks, credit card companies, or paging services.

On Hook Dialing

When you make a call using **HOOK**, you can listen to the other end through the one-way speaker of the machine, but they can't hear you unless you pick up the handset. Also, if you press **HOOK** again before you pick up the handset, the call will be disconnected.

Optional Settings When You Send a Fax Manually

- Resolution (See page 6-2, 6-12~13.)
- Contrast (See page 6-3.)
- Cover Page (See page 6-14~15.)
- Overseas Mode (See page 6-12.)
- Call Reservation (See page 6-18.)

Searching the Telephone Index (Only for FAX-715M/725M)

Once you have stored a name and number as a One-Touch number or as a Speed-Dial number, you can search for that name alphabetically using the Telephone Index. You can also dial a number directly from the Telephone Index.

KEYS TO PRESS

1. Press **TEL-INDEX**.
 2. Use the number keys to input the first character of the stored name, and press ◀ (left arrow) or ▶ (right arrow) to find the name.
 3. Pick up the handset, or press **HOOK**.
 4. Press **START** to begin dialing.
- Return the handset to its cradle or press **HOOK** to cancel the call.

THE DISPLAY WILL SHOW:

09/12/1996 15:25

TEL. INDEX

NJ OFFICE

NJ OFFICE

6. SENDING FAXES

A) DOCUMENT BASICS

The Size of Your Documents

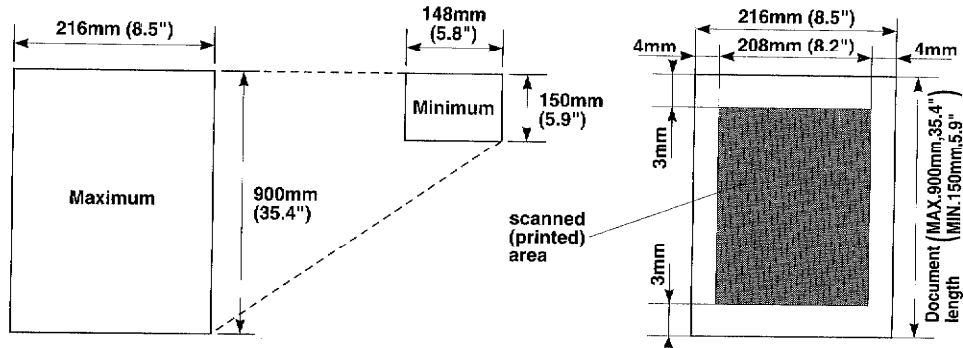

The size of the documents you want to send by fax should not be larger (or smaller) than your fax machine can accommodate. The documents should each be between 148 and 216 mm (5.8 and 8.5 inches) wide and between 150 and 900 mm (5.9 and 35.4 inches) long.

The maximum width of the scanned area is 208 mm (8.2 inches), which can be printed on the recording paper of the recipient's fax.

How to Insert the Document

To send a fax, first insert the document you wish to send, face down, in the document feeder. The top edge of the document should go in first, or the fax will be received up side-down.

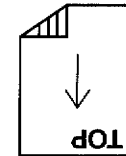

To prevent the document from going crooked as it is fed, adjust the paper guides to fit the width of the document.

NOTICE

About the Documents You Send...

Do not use documents that are curled, wrinkled, folded, ripped, or that contain staples, paper clips, paste, or tape. Also, do not use cardboard, newspaper, or fabric.

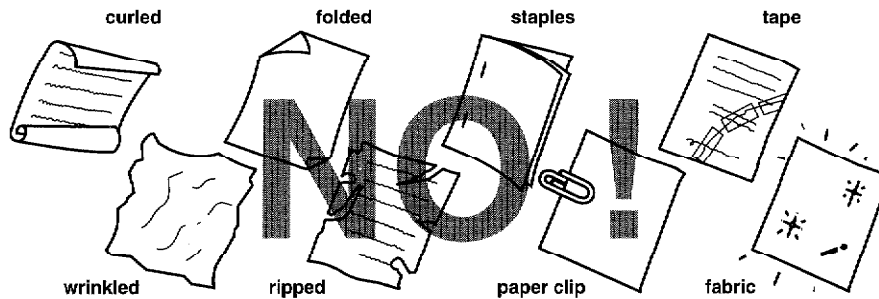

The Auto Document Feeder (ADF)

The Auto Document Feeder (ADF) automatically feeds documents (**up to 15 pages**) into the fax machine, one at a time. The thickness and weight of the documents should fall into the following categories:

Thickness: For one sheet: 0.07 to 0.12 mm (2.8×10^{-3} to 4.7×10^{-3} inches).
For multiple sheets: 0.07 to 0.10 mm (2.8×10^{-3} to 3.9×10^{-3} inches).

Weight: For one sheet: 52 to 85 g/m² (0.07×10^{-3} to 0.121×10^{-3} lbs/inch²).
For multiple sheets: 52 to 80 g/m² (0.07×10^{-3} to 0.114×10^{-3} lbs/inch²).

As a reference, please note that the paper on which this is printed has the following thickness and weight:

Thickness: 0.10mm (3.9×10^{-3} inches)

Weight: 80g/m² (0.114×10^{-3} lbs/inch²)

Before inserting documents into the document feeder, fan the sheets of paper to make sure the documents are not stuck together. Then tap the leading edge on a table so that all the pages are even when placed in the feeder. Make sure you always put the documents in face down.

Getting Ready to Send a Fax

SETTING THE RESOLUTION

You can choose a setting (STANDARD, FINE, SUPERFINE, or PHOTO) for the resolution any time before you press **START** or **COPY**. You can choose a setting by pressing the **RESOLUTION** key. (○ means light off. ● means light on.)

STANDARD FINE PHOTO S.FINE
○ ——— ○
The STANDARD resolution can be used for most typewritten text. When the STANDARD setting is on, both lights are off. Transmission speed is normal.

FINE FINE PHOTO S.FINE
● ——— ○
The FINE resolution is an ideal setting to use if you want to send documents that have small print. When the FINE setting is on, the FINE light will be lit. Transmission speed is slower than STANDARD.

SUPERFINE FINE PHOTO S.FINE
○ ——— ●
The SUPERFINE resolution is a good setting to use for documents with very small print or artwork. When the SUPERFINE setting is on, the S. FINE light will be lit. Transmission speed is slower than FINE.

PHOTO FINE PHOTO S.FINE
● ——— ●
The PHOTO resolution is ideal for sending documents that have varying shades of gray, such as photographs. The PHOTO setting is on when both lights are lit. Transmission speed is slower than FINE.

To set different resolutions for each page of a multi page document, refer to "Multiple Resolution Transmission" on page 6-12.

SETTING THE CONTRAST

The fax machine has automatic contrast control, but if you need to send a document that is very light or very dark, you may want to set the contrast yourself.

Use **SUPER LIGHT** to send a very light document.

Use **SUPER DARK** to send a very dark document.

KEYS TO PRESS

1. Insert the documents face down into the feeder.
2. Press **FUNCTION**.
3. Press **1**.
4. Press **4**.

The display will alternate messages.

5. Use ◀ (left arrow) or ▶ (right arrow) to select one of the settings, **AUTO**, **S.LIGHT**, or **S. DARK**.
Example: **S.LIGHT**.

6. Press **SET**.
7. Press **STOP** to exit.

THE DISPLAY WILL SHOW:

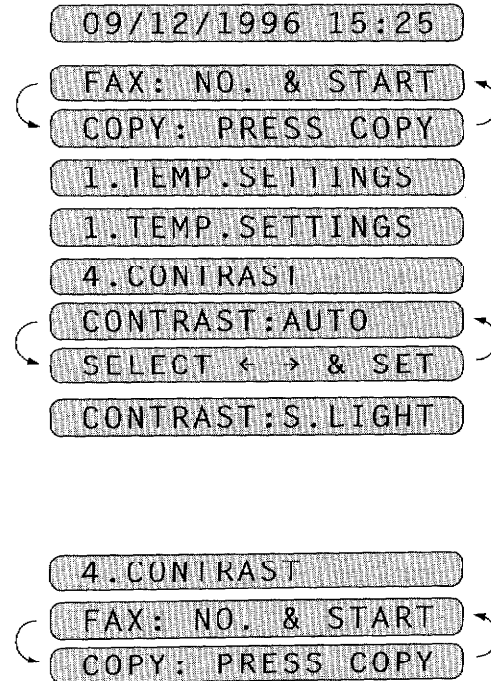

Then start the fax sending operation (see page 6-4) or copy (see page 9-1).

B) BASIC FAX TRANSMISSIONS**FOR YOUR INFORMATION*****Sending a Fax***

There are 3 basic ways of sending a fax:

1) Manual transmission:

You can talk or listen to the other party before you send a fax by picking up the handset and dialing the number. After the other party has finished talking and has pushed its **START** button, you will be able to send your fax by pressing your **START** key and putting the handset back down in its cradle. (If you call and all you hear is the chirping sound of a fax machine, you can go ahead and press your **START** key, and then put down the handset.)

2) Automatic transmission:

You can send a fax without picking up the handset or without pressing **HOOK** by dialing the fax number and then pressing **START**.

a. One-Touch Dialing

Press one of the One-Touch keys. (The numbers must be stored beforehand. See page 4-4.) Then press **START**.

b. Speed-Dialing

Press **SPEED DIAL**, then use the number keys to enter a two-digit number. For example, press "05" for 5. (The numbers must be stored beforehand. See page 4-6.) Then press **START**.

c. Telephone Index (Only for FAX-715M/725M)

You can use the Tel-Index to make telephone or fax calls. (See page 5-2.)

3) Timer transmission:

It is possible to send documents at a later time by using the **TIMER** function. (See page 6-7.)

Talking to the Other Party When Sending a Fax

When you are sending a fax manually and you hear the recipient's voice instead of fax tones, you can use the handset to have a conversation. When or if you want to then send a fax, ask the person on the other line to press **START** on his/her fax machine and when you hear fax tones you can press **START** to begin sending your fax.

Sending a Fax Automatically**KEYS TO PRESS**

1. Insert the documents face down into the feeder.

THE DISPLAY WILL SHOW:

09/12/1996 15:25

FAX: NO. & START

COPY: PRESS COPY

2. Enter a fax number.
Example: One-Touch dialing.
3. Press **START**.

NJ OFFICE

DIALING

SENDING P.01

Sending a Fax Manually

KEYS TO PRESS

1. Insert the documents face down into the feeder.
2. Pick up the handset or press **HOOK** and listen for the dial tone.
3. Enter the fax number.
You can use manual dialing, One-Touch dialing, Speed Dialing, or Tel-Index (Only for FAX-715M/725M).
4. When you hear a fax tone, press **START**.
Your fax machine will begin sending the documents.
5. Return the handset to its cradle, if you did not use **HOOK**.

THE DISPLAY WILL SHOW:

09/12/1996 15:25

FAX: NO. & START

COPY: PRESS COPY

ENTER FAX NO.

PRESS START KEY

NJ OFFICE

SENDING

Automatic and Manual Re-dialing

If a number you have dialed is busy or your call did not go through for some other reason, you can re-dial that number. There are two ways to re-dial, "automatic" and "manual." Automatic redialing can only be used for faxes that were sent using automatic transmission—not for telephone calls. The factory setting is "auto re-dial on" and it will re-dial the number 3 times at 5 minute intervals automatically before giving up. The fax machine will also re-dial the last dialed number when you press **REDIAL/PAUSE** (manual re-dialing).

C) ADVANCED FAX TRANSMISSIONS

***Sending a Fax by Using Quick-Scan (Memory Transmission)
(Only for FAX-715M/725M)***

If you are faxing a set of documents that are confidential in nature or you just need your original documents back right away, you don't have to stand at the machine and wait for the transmission of each page to be completed. You can use Quick-Scan in order to get your original documents back before transmission.

FOR YOUR INFORMATION

If You Get a MEMORY FULL Message When Trying to Send a Fax by Using Quick-Scan

If the memory becomes full when scanning page one, the display shows "PRESS STOP KEY", then press **STOP** to abort the job.

If the memory becomes full on page 2 or more of a multi-page document, you will be prompted to press **START** to send the portion already scanned, or **STOP** to abort the job.

KEYS TO PRESS

1. Insert the documents into the feeder.
2. Press **Q.SCAN**.
The display indicates how much memory is available.
3. Enter the fax number.
4. Press **START** to begin scanning the documents into memory. Once completed, the fax machine will dial the destination.

THE DISPLAY WILL SHOW:

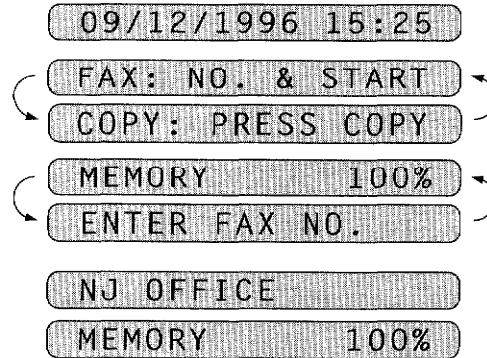

Delayed Transmission

You can set the timer to send documents at a later time (up to 24 hours later). Your fax machine will also produce a report, the "Delayed Sending Report", after the fax is sent. You can set up to three different documents for delayed transmission on FAX-715M/725M, and one document on FAX-615/625/635/675.

KEYS TO PRESS

1. Insert the documents into the feeder.
2. Press **Q.SCAN** to use memory transmission, or you can send your fax normally (Only for FAX-715M/725M.).
3. Press **FUNCTION**.
4. Press **1**.
5. Press **1**.
6. Enter the time in 24-hour format using the number keys.
Example: **19:45** (7:45 P.M.).
7. Wait for two seconds.
8. Press **STOP**.
9. Enter the fax number.
10. Press **START**.
The fax machine will wait until the specified time to call.

THE DISPLAY WILL SHOW:

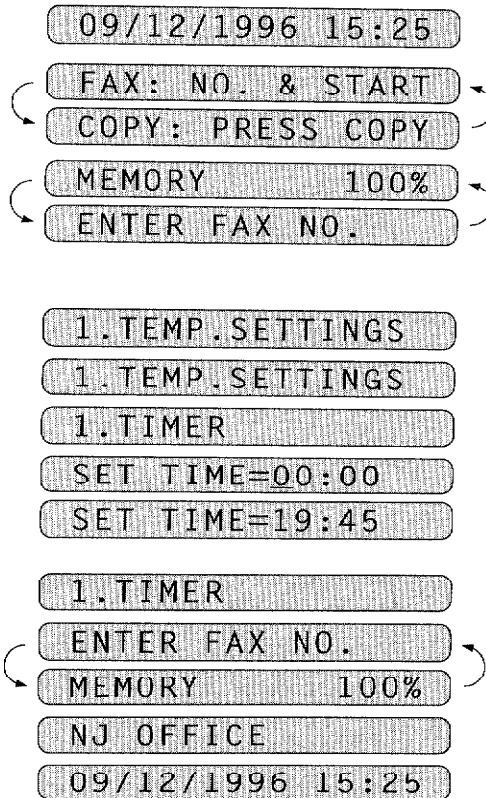

Setting the Daily Timer (for Delayed Transmissions)

The Daily Timer function lets you send a fax at a set time every day. This is handy for sending delayed jobs that must go out at the same time daily. Once you make this setting, you don't have to enter the time everyday. The setting will stay the same until you change it. So you can use it everyday, or only on days when you need it.

KEYS TO PRESS

1. Press **FUNCTION**.
2. Press **7**.
3. Press **2**.

THE DISPLAY WILL SHOW:

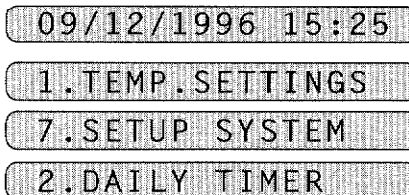

4. Enter the time in 24-hour format using the number keys.
Example: **19:45** (7:45 P.M.).
5. Wait for two seconds, press **STOP** to exit.

ENTER TIME:00:00
 ENTER TIME:19:45
 2. DAILY TIMER

Broadcasting (Only for FAX-715M/725M)

By using the numbers you have stored for One-Touch dialing, Speed-Dialing, or group dialing, you can send faxes automatically to a maximum of 60 different locations at once. You can not broadcast to a number that has not been stored into memory.

KEYS TO PRESS

1. Insert the documents into the feeder.
2. Press **Q.SCAN**.
3. Enter the One-Touch and Speed-Dial numbers, one after the other, or only a group number.
Example: Group number.
4. Press **START** and the fax machine will read the documents into memory, and then start sending faxes to all the numbers you entered.

THE DISPLAY WILL SHOW:

09/12/1996 15:25
 FAX: NO. & START
 COPY: PRESS COPY
 MEMORY 100%
 ENTER FAX NO.
 ALL BROTHER
 MEMORY 100%
 DIALING
 SENDING P.01

Ch. 6

FOR YOUR INFORMATION

Getting Familiar with the Broadcasting Function

- * To stop the broadcast in progress, press **STOP**.
- * Enter the chain dialing numbers as you normally would, but keep in mind that each key counts as one location, so the number of locations you can call becomes limited. You have up to 60 locations. You can call with One-Touch, Speed-Dialing, and group numbers.
- * If the line is busy or for some other reason a connection could not be made during broadcasting, the fax machine will re-dial the number automatically. (See page 6-5.)
- * If the memory is full, press **STOP** to abort the job or press **START** to send the portion that is in the memory (if more than one page has been scanned.) (See page 6-6.)

- Helpful Hints**
1. Use the Telephone Index to help you choose the numbers you want to broadcast. (See page 5-2.)
 2. After transmission is completed, a Broadcast Report will be printed automatically to let you know the result of transmission.

Sending by Multi-Transmission (Only for FAX-715M/725M)

Use multi-transmission for sending several different faxes to several destinations at once. For example, you can fax "Document A" to one destination and "Document B" to another destination automatically.

This is not to be confused with Broadcasting, which is sending one document(s) to many destinations.

If you wish, you can combine this function with broadcasting so that you can fax different documents to different lists of people at the same time. To do this, you store various sets of documents in memory. Then, for example, you can automatically fax "Document A" to one list of people and "Document B" to another list of people. You can preset 3 different documents including timer transmission in memory; if you set one timer transmission, multi transmission is available for two destinations.

After scanning documents, your fax machine will start sending them in scanned order.

If you press only **Q.SCAN** instead of **SHIFT + Q.SCAN** for the last document, your fax machine will start dialing without waiting for 30 seconds.

KEYS TO PRESS

1. Insert "Document A" into the feeder.
2. Press **SHIFT + Q.SCAN** together to send by multiple transmission. The display shows remaining memory.
3. Enter the fax number. (Or a series of numbers if you are broadcasting.)
4. Press **START** to start scanning documents.
5. Insert "Document B" within 30 seconds after "Document A" has been scanned. (If you wait more than 30 seconds to scan another document, the machine will begin to send the document(s) it has.)

THE DISPLAY WILL SHOW:

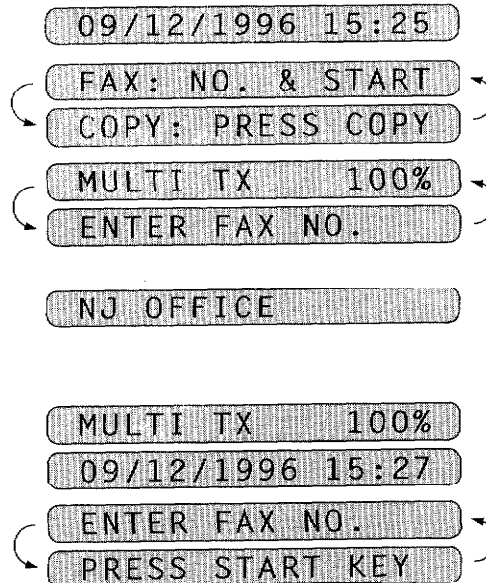

6. Repeat the step 1, 2, 3, 4 for the third document.
7. After 30 seconds, your fax machine will start sending the documents in scanned order.

MULTI TX 70%

DIALING

Interrupting the Timer and Polled Job

You can send a fax without canceling the timer (see page 6-7) or polled waiting (see page 8-2) with documents in the feeder by “interrupting” it. When you interrupt the timer to send a “new” set of documents, the fax machine does not re-dial the number automatically if it is busy. Also, you can not use the function mode when you are interrupting the timer or polled waiting.

Example: TIMER WAITING with a document in the feeder.

KEYS TO PRESS

1. Press **FUNCTION**.
2. Press **0**.
3. Wait for two seconds.
4. Remove documents from the fax machine.
5. Place the “new” documents into the feeder.
6. Enter the new fax number for the documents you are sending now, then press **START**.
7. After the transmission is finished, place the “old” documents back into the feeder.
8. Press **FUNCTION** and **0** to restore the timer.

THE DISPLAY WILL SHOW:

TIMER WAITING

1. TEMP. SETTINGS

0. INTERRUPT

REMOVE DOCUMENT

INSERT DOCUMENT

FAX OR COPY

FUNC 0 TO RESET

DIALING

SENDING P. 01

INSERT DOCUMENT

FAX OR COPY

FUNC 0 TO RESET

0. INTERRUPT

TIMER WAITING

Ch. 6

Canceling a Job

Use the cancel job function to permanently remove scheduled tasks such as polling or polled waiting (see page 8-2) and a timer job (delayed sending) (see page 6-7) from your fax machine.

Example: **TIMER WAITING** with documents in the feeder.

KEYS TO PRESS

1. Press **FUNCTION**.
2. Press **2**.
Any waiting jobs that have been set up will appear in the display.
If no jobs are waiting to be processed, a "NO JOB WAITING" message will appear in the display.
3. Use ◀ (left arrow) or ▶ (right arrow) to select the job you wish to cancel.
4. Press **SET**.
5. Press **1** to cancel the selected job, or **2** to exit without canceling.
If **1** is selected, the job will be cleared and the next job in the queue will appear in the display.
6. To cancel the next job, press **1** again.
To exit, simply press **2**.

THE DISPLAY WILL SHOW:

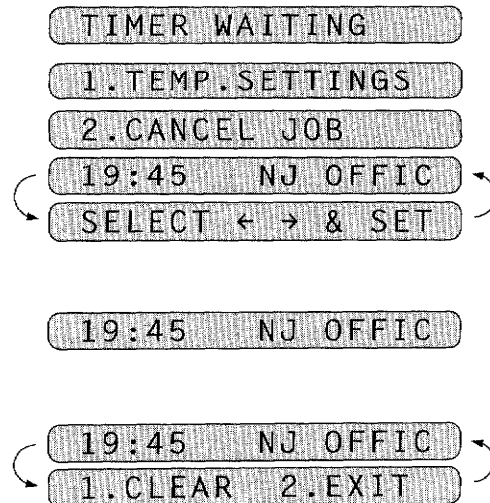

D) FAX TRANSMISSION OPTIONS

Setting the Overseas Mode

If you experience difficulty with sending faxes overseas, you may want to use the Overseas mode. Using the Overseas mode is an effective way to send faxes overseas. After sending your fax, the overseas mode will switch itself OFF.

KEYS TO PRESS

1. Insert the documents into the feeder.
2. Press **FUNCTION**.
3. Press **1**.
4. Press **6**.
5. Press ◀ (left arrow) or ▶ (right arrow) to switch to ON.
6. Press **SET**.
7. Press **STOP** to exit.
8. Then start the fax sending operation. (See page 6-4~5.)

THE DISPLAY WILL SHOW:

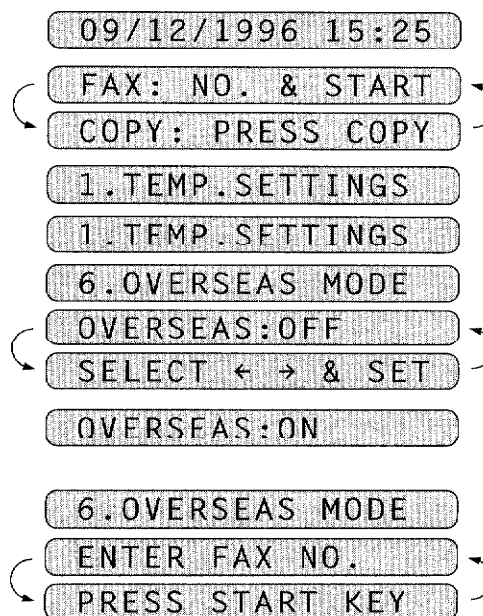

Ch. 6

Setting Your Fax Machine for Multiple Resolution Transmission

This is a temporary setting for the current transmission job only. You can set the resolution of the documents you send by pressing **RESOLUTION**. Once you set the resolution, all the pages will be sent at the same resolution. However, there may be times when you want to send some pages at one resolution, such as "standard", and other pages in another resolution, such as "photo." If you send all pages in photo resolution, for instance, it would take a great deal of time. It is better to specify the resolution for each page to minimize transmission time. This is made possible by using the 1.TEMP. SETTINGS function. The resolution will revert to STANDARD after the documents have been sent.

KEYS TO PRESS

1. Insert the documents into the feeder.

THE DISPLAY WILL SHOW:

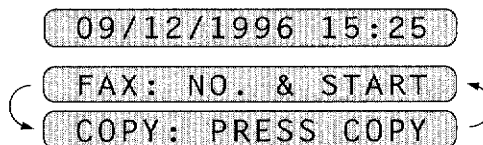

2. Press **FUNCTION**.
3. Press **1**.
4. Press **5**.

5. Press ◀ (left arrow) or ▶ (right arrow) to find the resolution you want for the first page of your documents.
Example: FINE.
6. Press **SET**.
Return to step 5 for setting the resolution for page 2 and the following pages.
7. When you finish setting the resolution for all your pages, press **STOP**.
8. Enter the fax number.
9. Press **START**.

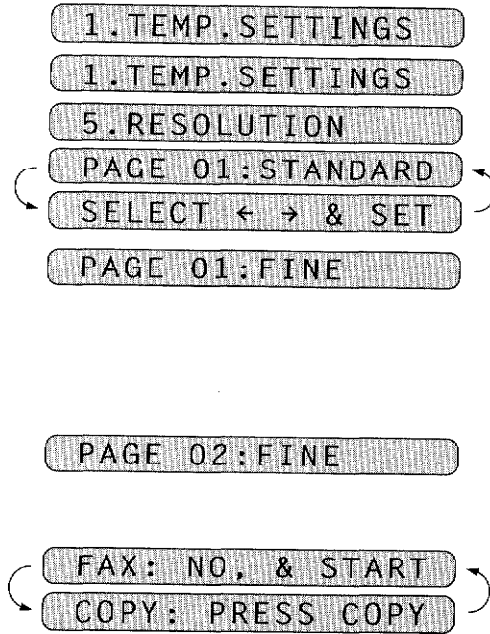

Gray Scale (Only for FAX-615/625)

You can set initial gray scale level to either 16 or 32. The default setting is 32. This is the initial level of photo mode, which is effective for sending photographs. If you try to send a document in 32 level photo mode and the receiving machine does not have super fine mode, the machine will fall back to the 16 level automatically. Therefore, if you send frequently to such a machine, you may want to set the initial gray scale level to 16.

KEYS TO PRESS

1. Press **FUNCTION**.
2. Press **5**.
3. Press **4**.

4. Press ◀ (left arrow) or ▶ (right arrow) to choose either 16 or 32.
Example: 16.
5. Press **SET**.
6. Press **STOP** to exit.

THE DISPLAY WILL SHOW:

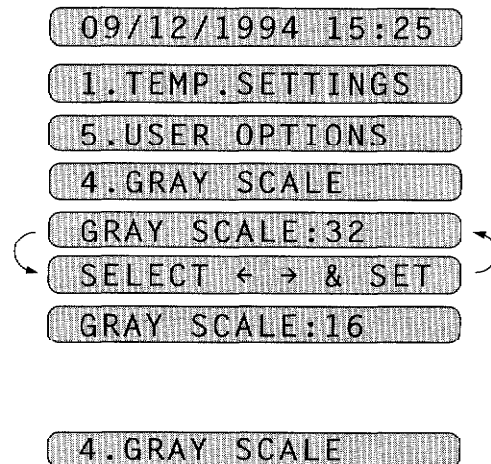

Sending a Fax with an Electronic Cover Page Message

An automatic Cover Page will allow you to send details of who the fax is going to, who it is from and when it was sent. This is what the Cover Page looks like:

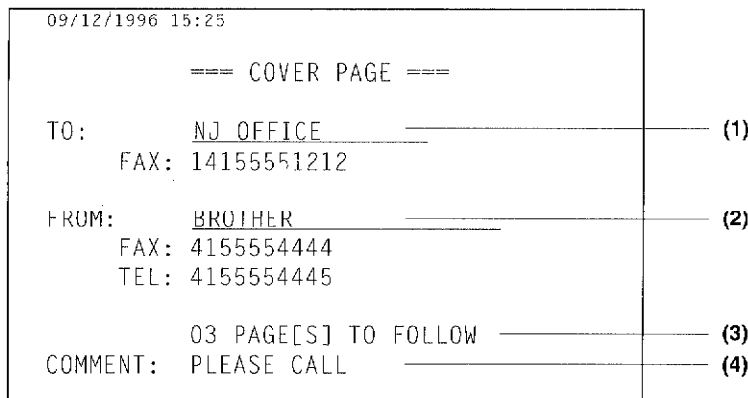

- (1) The "TO" information comes from the One-Touch or the Speed-Dial memory. If you are dialing manually, the name of the destination will be left blank.
- (2) The "FROM" information comes from the Station ID.
- (3) The number of pages you are sending. When Cover Page is sent each time by using the automatic settings (see page 6-16), the number of pages will be left blank. If you have used the temporary Cover Page setting (see page below), the number of pages you entered will be listed.
- (4) Your comments. You may customize the comments (see page 6-15).

KEYS TO PRESS

1. Insert the documents into the feeder.
2. Press **COVERPAGE**.
3. Use ◀ (left arrow) or ▶ (right arrow) to select the comment you want.
Example: 2. **PLEASE CALL**.
4. Press **SET**.
5. Enter the number of pages you are sending. (Enter "00" to leave the number of pages blank.)
Example: **03**.
6. Enter the fax number and press **START**.

THE DISPLAY WILL SHOW:

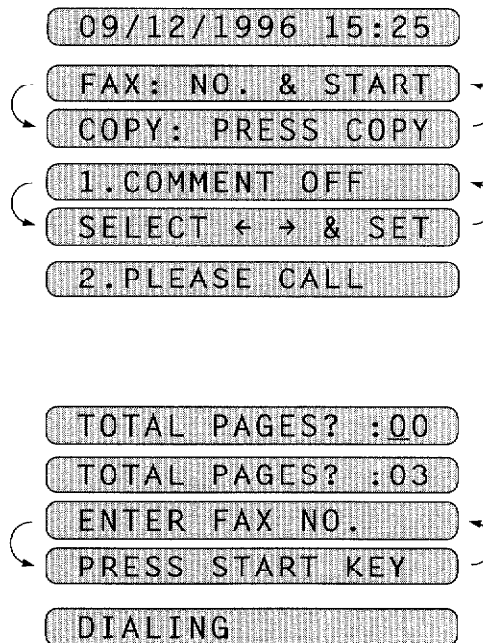

FOR YOUR INFORMATION

The Comments Selection on the Cover Page

You can choose one comment from among 4 options for FAX-615/625/635/675 and 6 options for FAX-715M/725M. The first option is to send no comment at all. The next 3 are built-in comments, and the last two available on FAX-715M/725M are ones you can enter yourself.

- 1. COMMENT OFF
- 2. PLEASE CALL
- 3. URGENT
- 4. CONFIDENTIAL
- 5. (Your own customized comment up to 27 characters). } Only for FAX-715M/725M
- 6. (Your own customized comment up to 27 characters). } (See page below)

Customizing Your Cover Page Comment (Only for FAX-715M/725M)

You can customize the comment on your Cover Page as follows:

KEYS TO PRESS	THE DISPLAY WILL SHOW:
1. Press FUNCTION .	09/12/1996 15:25
2. Press 7 .	1. TEMP. SETTINGS
3. Press 6 .	7. SETUP SYSTEM
	6. SET COVERPAGE
	5.
	SELECT ← → & SET
	5.
4. Press ◀ (left arrow) or ▶ (right arrow) to select 5 or 6 where you wish to store a comment. Example: 5.	5. _
5. Press SET .	5. TOP SECRET
6. Enter your customized comment by using the number keys (up to 27 characters). (See page 3-8-9 for more details.) Example: TOP SECRET .	
7. Press SET .	6. SET COVERPAGE
8. Press STOP to exit.	

Printing the Cover Page

You can print a Cover Page to check the format.

KEYS TO PRESS

1. Press **FUNCTION**.
2. Press **3**.
3. Press **4**.
(Press **3** on FAX-615/625/635/675.)
4. Press **START**.

THE DISPLAY WILL SHOW:

- 09/12/1996 15:25
- 1. TEMP. SETTINGS
- 3. PRINT REPORTS
- 4. COVERPAGE
- PRESS START KEY
- PRINTING

To Always Send a Cover Page

If you often send an automatic Cover Page, you can set it to ON to avoid having to set up the details of the Cover Page each time. Here is how you can switch the setting for the automatic Cover Page to ON or OFF:

KEYS TO PRESS

1. Press **FUNCTION**.
2. Press **5**.
3. Press **3**.
4. Press ◀ (left arrow) or ▶ (right arrow) to choose ON or OFF.
Example: ON.
5. Press **SET**.
6. If you selected ON, you need to select a comment, by pressing ◀ (left arrow) or ▶ (right arrow).
Example: 2.PLEASE CALL. (See page 6-15.)
7. Press **SET**.
8. Press **STOP** to exit.

THE DISPLAY WILL SHOW:

- 09/12/1996 15:25
- 1. TEMP. SETTINGS
- 5. USER OPTIONS
- 3. COVERPG ON/OFF
- COVERPAGE: OFF
- SELECT ◀ ▶ & SET
- COVERPAGE: ON
- 1. COMMENT OFF
- SELECT ◀ ▶ & SET
- 2. PLEASE CALL
- 3. COVERPG ON/OFF

Sending a Fax When the Cover Page Is ON

If you have the Cover Page ON/OFF setting to ON, the total number of pages will not be printed on the Cover Page. Also, the comment you selected when you set it to ON will be printed on all the Cover Pages you send.

Even if the Cover Page ON/OFF setting is ON, you can avoid sending an automatic Cover Page by pressing **COVERPAGE** once to turn off the Cover Page for that transmission.

If you want the total number of pages sent to be printed on the cover page, press **COVERPAGE** once to set the COVERPAGE ON/OFF option to OFF. Then press **COVERPAGE** once again and enter the number of pages. (See page 6-14.)

KEYS TO PRESS

1. Insert the documents into the feeder. The display will say "COVERPAGE ON" for one second.
2. Enter the fax number.
3. Press **START**.
Your machine will begin transmitting the Cover Page and original document.

THE DISPLAY WILL SHOW:

09/12/1996 15:25
 COVERPAGE ON
 FAX: NO. & START
 COPY: PRESS COPY
 NJ OFFICE
 DIALING
 SEND COVERPAGE
 SENDING P.01

Sending a Fax with Call Reservation

You can send a fax and then talk to the recipient using the Call Reservation feature. After your fax has been printed on the receiving end, the receiving fax machine will ring as if it were receiving a telephone call. If the recipient picks up the handset, your fax machine will ring. Then you can pick up your handset and start a conversation. If you have both Call Reservation and Call Back Message set to ON and the recipient does not pick up the handset when it rings, your fax machine will leave a fax message asking them to call you.

KEYS TO PRESS

1. Insert the documents into the feeder.
2. Press **FUNCTION**.
3. Press **1**.
4. Press **3**.
5. Press ◀ (left arrow) or ▶ (right arrow) to select Call Reservation ON or OFF.
Example: Call Reserve ON.
6. Press **SET**.
7. Press ◀ (left arrow) or ▶ (right arrow) to select Call Back Message ON or OFF.
Example: Call Back Message ON.
8. Press **SET**.
9. Press **STOP**.

THE DISPLAY WILL SHOW:

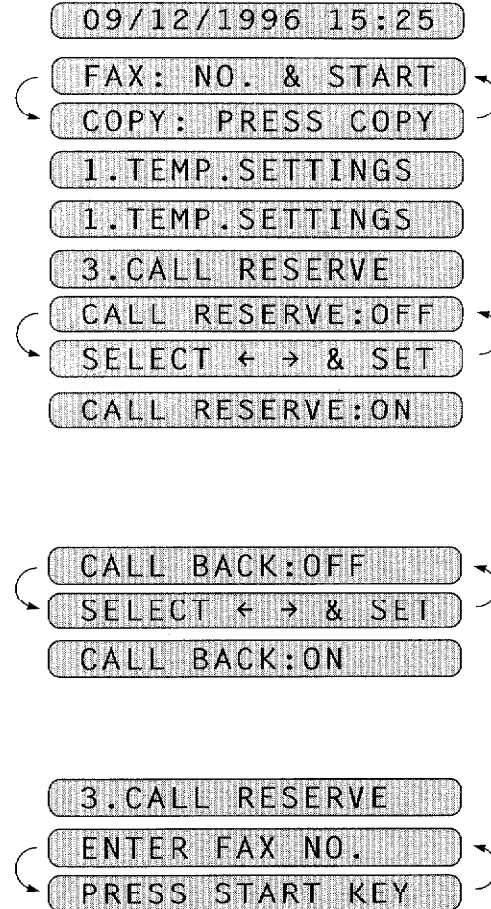

10. Enter the fax number.
11. Press **START**.
12. Pick up your handset if it rings.

NJ OFFICE
DIALING

09/12/1996 15:25
 === CALL BACK MESSAGE ===
 TO: NJ OFFICE
 FAX: 14155551212
 FROM: BROTHER
 PLEASE CALL AT [TEL] 4155554445
 [FAX] 4155554444

FOR YOUR INFORMATION

Using the Call Reservation Function

1. There are some fax machines that will not respond to this function.
2. When you use auto re-dialing, you cannot use the Call Reservation function, but if Call Back Message is ON, your fax machine will leave a Call Back Message to ask the other party call you.
3. You cannot use Call Reservation with the timer or with the polling function.
4. **You must register your Station ID number to set Call Back Message: ON.**
(See page 4-3.)

Printing the Call Back Message

You can print a sample Call Back Message to check the format.

KEYS TO PRESS

1. Press **FUNCTION**.
2. Press **3**.
3. Press **5**.
(Press 4 on FAX-615/625/635/675.)
4. Press **START**.

THE DISPLAY WILL SHOW:

09/12/1996 15:25
 1. TEMP. SETTINGS
 3. PRINT REPORTS
 5. CALL BACK MSG
 PRESS START KEY
 PRINTING

ECM (Error Correction Mode) (Only for FAX-715M/725M)

The Error Correction Mode (ECM) is a way for the machine to check the integrity of a fax transmission while it is in progress. ECM transmissions are possible only between machines that both have the ECM feature. If they do, you can send and receive fax messages that are continually checked for their integrity.

Sufficient memory must be available in your machine for this feature to work.

Error Re-Transmission (Only for FAX-715M/725M)

Error Re-Transmission is helpful when the receiving machine does not have ECM. Even though your machine cannot check the integrity of the message, it will resend the page(s) affected after occurrences of accidental noise have caused an error.

KEYS TO PRESS

1. Press **FUNCTION**.
2. Press **5**.
3. Press **4**.
4. Press ◀ (left arrow) or ▶ (right arrow) to choose either ON or OFF.
Example: ON.
5. Press **SET**.
6. Press **STOP** to exit.

THE DISPLAY WILL SHOW:

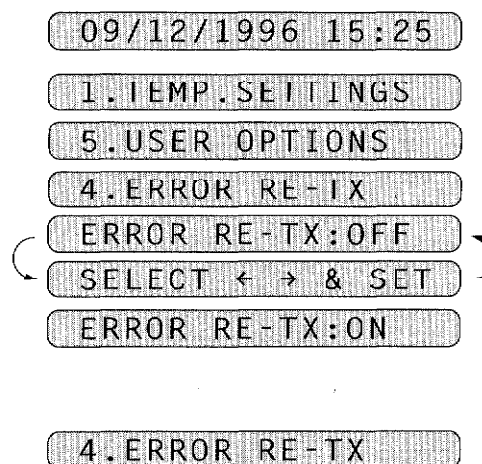

- This feature is available only for memory transmission using Quick-Scan (see page 6-6~9).

Next-FAX Reservation (Only for FAX-625/635/675/715M/725M)

You can use Next-FAX Reservation for sending a fax when the fax machine is busy receiving or transmitting from memory. This function saves you from having to wait until the incoming fax has printed or the fax stored in memory has finished transmission. To use the Next-FAX Reservation feature insert the documents as you normally would and follow a few other simple steps.

KEYS TO PRESS

1. Insert the documents into the feeder.
2. Enter a fax number.
3. Press **START**.
4. Press **SET**.

THE DISPLAY WILL SHOW:

RECEIVING P.01

ENTER No & START

14155551234

PRESS SET

NEXT-FAX RESERVD

DIALING

If a One-Touch or SPEED DIAL number is selected that is not stored, a warning beep will sound.

FOR YOUR INFORMATION



1. Next-FAX Reservation cannot be used when there are documents in the document feeder awaiting timer transmission or polled waiting or when the interrupt function is in use.
2. When you are making a call using Next-FAX Reservation, you can dial manually, or use One-Touch, Speed-Dial, Redial, or Chain dialing. However, when you use One-Touch dialing, the screen will display only the number of the One-Touch number you are using, such as "*01" and not the name of the person you are calling. Similarly, if you use Speed-dialing, the screen will show you only the Speed-Dial number, such as "#02".
3. You can set the resolution for Next-FAX Reservation by pressing **RESOLUTION**, but you can not change any settings using the **FUNCTION** key. (For example you cannot change a setting for multiple resolution transmission by using function mode.)
4. To cancel a Next-FAX Reservation, remove the documents and press **STOP**.

7. RECEIVING FAXES AND OTHER CALLS

A) BASIC SETUP TO RECEIVE FAXES

Selecting an Answer Mode

There are four answer modes for your fax machine. Choose the mode that suits your needs by pressing the MODE button repeatedly until you have changed the AUTO and F/T lights to the setting you want. For more information about a particular mode, refer to the page number given. (○ means light off. ● means light on.)

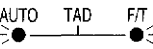
Answer Mode	How it Works	See Page
1. MANUAL 	You control the phone line and must answer every call yourself. Use this mode when you are using a computer modem on the line or if you receive very few fax messages.	7-2
2. AUTO 	(Automatic) The fax machine automatically answers every call with fax tones (dedicated fax line). You can not receive a telephone call, but you can use the line to call out.	7-2
3. F/T 	(Fax/Telephone) The fax machine controls the phone line and automatically answers every call. If it answers and hears fax tones coming over the line, it will receive the fax message. If the fax machine answers and does not hear fax tones, it will ring for you to pick up a phone and take over the call. This mode is for people who do not use an answering machine. You can not have a telephone answering device in a separate phone jack on the same phone line. <p>You must set the Ring Delay and F/T Ring Time. If you have extension phones on the line, set the Ring Delay to 4 rings.</p>	7-3
4. TAD 	(Telephone Answering Device) The answering machine controls the phone line and answers every call. As soon as the TAD answers, the fax machine listens for fax tones; if it hears them it will take over the call and receive the fax message. The TAD must be a physical device that is plugged into the EXT jack of the fax machine. Your fax machine will not work with an outside telephone answering service. TAD mode can be set so you can leave it turned on when you are at the fax machine and still have time to answer your calls before the TAD picks up; you do not have to change modes when you come and go.	7-10

Ch. 7

Manual Reception (MANUAL Mode)

When you set the Answer Mode to MANUAL, you must answer each incoming call yourself. Here is what you should do when using MANUAL Mode:

If You Get a...	Then You Should...
1. Regular phone call	Talk as you normally would.
2. Phone call and request to send a fax	Press START when finished talking, and replace the handset. Note: Sender must also press START .
3. Fax tone...	Press START , and replace the handset.

Automatic Fax Only Reception (AUTO Mode)

You can receive all your faxes automatically in Automatic Fax Reception mode (AUTO light is ON). Select this mode by pressing **MODE**.

Setting the Ring Delay

You can set up the number of rings before the fax machine will receive automatically in AUTO and F/T modes.

KEYS TO PRESS

1. Press **FUNCTION**.
2. Press **6**.
3. Press **2**.
4. Press ◀ (left arrow) or ▶ (right arrow) repeatedly until you find the number of rings you want.
Example: 00.

When you set 00, you can receive your incoming faxes with no rings.

5. Press **SET**.
6. Press **STOP** to exit.

THE DISPLAY WILL SHOW:

09/12/1996 15:25

1. TEMP. SETTINGS

6. TEL OPTIONS

2. RING DELAY

RING DELAY: 02

SELECT ◀ ▶ & SET

RING DELAY: 00

2. RING DELAY

The F/T Switch (F/T Mode)

When you share one line for your telephone and fax machine, in the F/T switch mode, the fax machine can determine whether an incoming call is a fax or a telephone call. (See Chart below.)

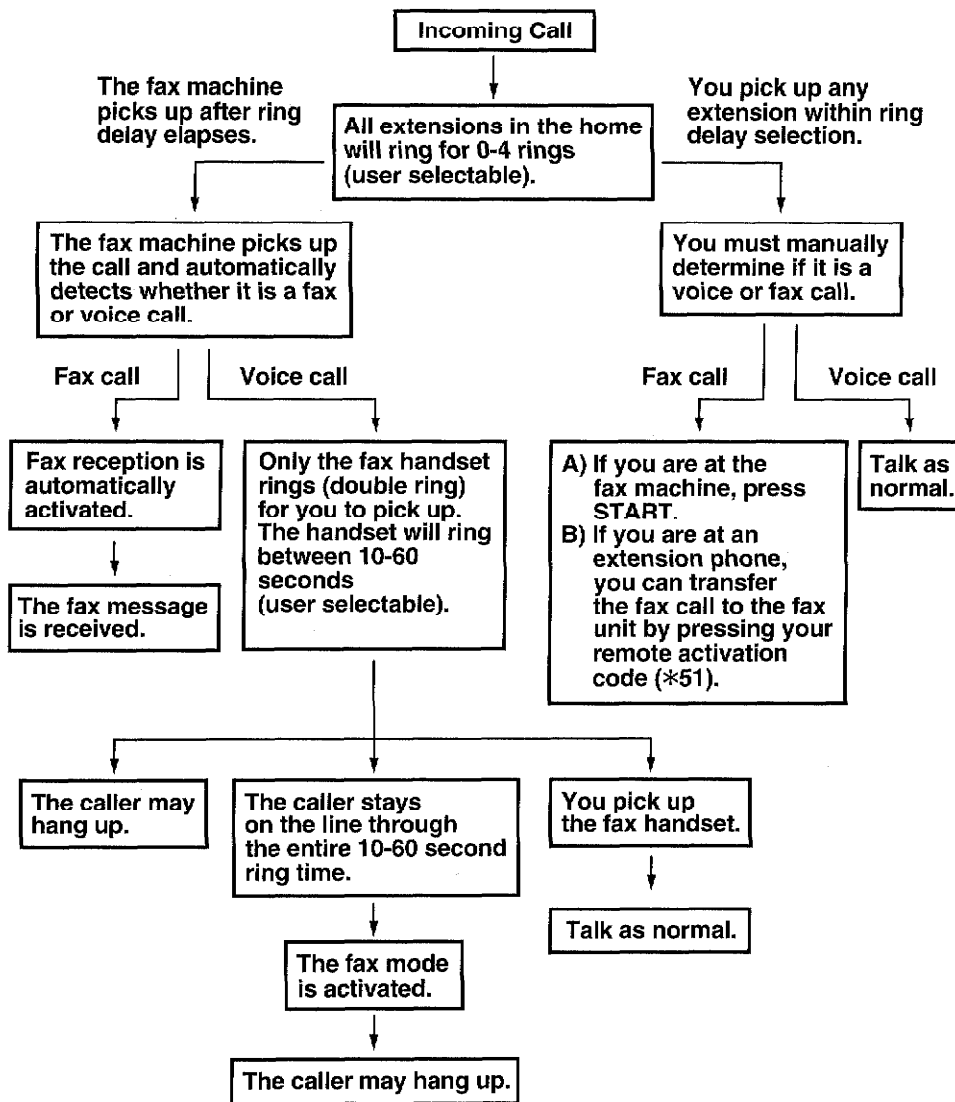

Ch. 7

Setting the F/T Ring Time

You can specify the maximum time you want the fax machine to ring (double ring) to notify you after it has answered a telephone call; there are four predefined settings: 10, 20, 30, or 60 seconds. During this time, only the fax machine will ring. No other phones on the same line will ring.

KEYS TO PRESS

1. Press **FUNCTION**.
2. Press **6**.
3. Press **4**.
4. Press ◀ (left arrow) or ▶ (right arrow) repeatedly until you find the setting you want.
Example: 10 sec.
5. Press **SET**.
6. Press **STOP** to exit.

THE DISPLAY WILL SHOW:

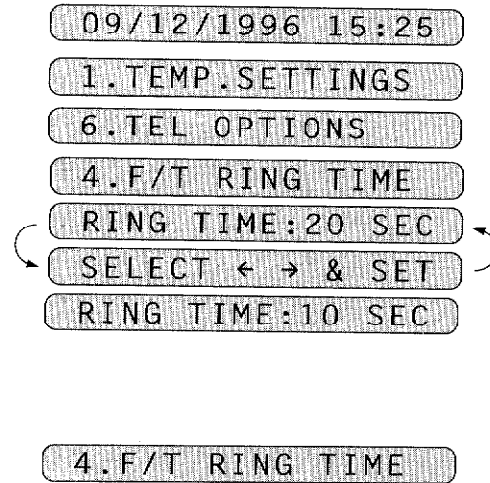

Smoothing

The smoothing feature enhances the appearance of incoming faxes by making the lines smooth and takes no additional time. This function does not apply to outgoing faxes, or to lists or reports you print. The initial setting is ON.

KEYS TO PRESS

1. Press **FUNCTION**.
2. Press **5**.
3. Press **1**.
4. Press ◀ (left arrow) or ▶ (right arrow) to choose ON or OFF.
Example: OFF.
5. Press **SET**.
6. Press **STOP** to exit.

THE DISPLAY WILL SHOW:

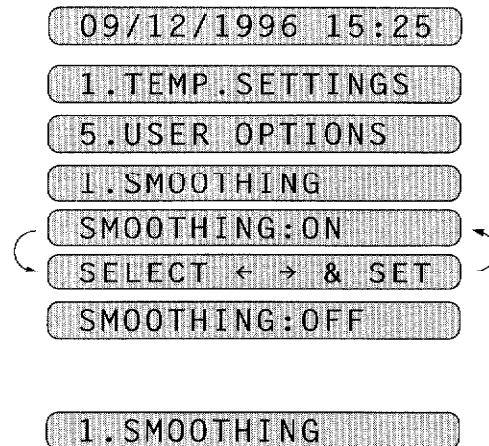

Speaker Volume

There are three settings available for the speaker volume, OFF, LOW, or HIGH. This setting controls the loudness of the fax machine's speaker, which is connected to the phone line. The initial setting is LOW.

KEYS TO PRESS

1. Press **FUNCTION**.
2. Press **6**.
3. Press **3**.
4. Press ◀ (left arrow) or ▶ (right arrow) to choose a setting either OFF, LOW, or HIGH.
Example: HIGH.
5. Press **SET**.
6. Press **STOP** to exit.

THE DISPLAY WILL SHOW:

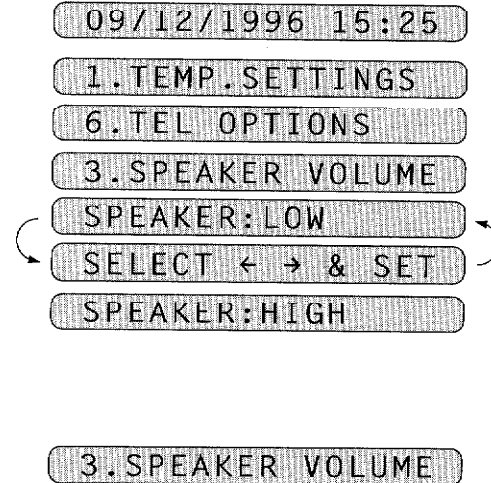

Ring Volume

You can set the ring volume to either OFF, LOW or HIGH. The initial setting is HIGH. Even if you select OFF, the ring volume will be LOW for F/T ringing, Call Reservation ringing and for Distinctive ringing if it is SET.

KEYS TO PRESS

1. Press **FUNCTION**.
2. Press **6**.
3. Press **5**.
4. Press ◀ (left arrow) or ▶ (right arrow) to choose either OFF, LOW, or HIGH.
Example: LOW.
5. Press **SET**.
6. Press **STOP** to exit.

THE DISPLAY WILL SHOW:

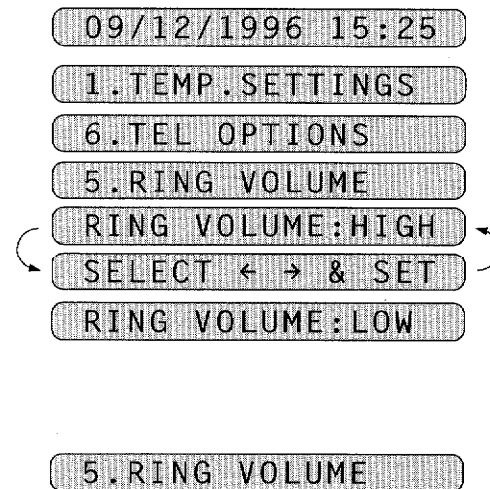

FOR YOUR INFORMATION

***Reception into Memory/Out of Paper Reception
(Only for FAX-715M/725M)***

If the paper roll becomes empty, the LCD will display the message "PAPER ROLL EMPTY". Simply load a new roll of paper. (See page 1-5.)

Your fax machine will store incoming faxes in its memory automatically if it runs out of paper. The contents of the memory will be printed when you replace the new recording paper. The memory will not be lost as long as you do not turn off the machine or disconnect the power.

B) REMOTE ACTIVATION

What is Remote Activation?

If you answer a call that is a fax message, you can use the Remote Activation Code to make your fax machine take over the call. If your fax machine answers a telephone call that is for you, you can use the Remote Deactivation Code to pick up the call at an extension phone. (You do not need a code to take over a call at the fax machine.) You must use a touch tone phone.

FOR YOUR INFORMATION

Connecting an External or Extension Telephone

You may connect an external telephone to your fax machine, as shown below. Use the "EXT." jack on your fax machine. Alternately, you may wish to use this "EXT." jack to connect a telephone answering device (TAD). An extension phone is a telephone that is plugged into a separate wall jack on the same phone line.

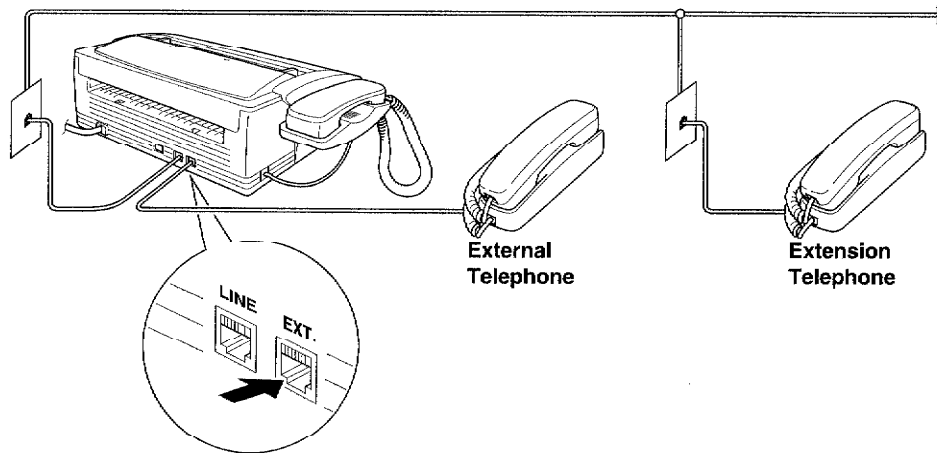

If the external telephone is in use, the warning message "EXT. TEL IN USE" will be displayed on the fax LCD. When the handset on the fax machine is picked up, an alarm will sound. You can disconnect the external phone and switch to the fax machine's handset by pressing **HOOK**.

Using Remote Codes

The Remote Activation Code (*51) is used in F/T mode and TAD mode. The Deactivation Code (#51) is used only in F/T mode.

Using the Activation Code:

When you are at the fax machine, you will probably answer incoming calls before your fax machine or answering machine is programmed to pick up. **If you answer a call and no one seems to be on the line, assume it is a fax message. Do not hang up.** You must activate your fax machine to take over the call first. (If you are holding the fax handset, just press START and hang up.) If you are on an extension or external phone, **press *51 and wait for your fax machine to respond before you hang up.** After 3 seconds you will hear receiving tones (chirps) through the handset. Then hang up. You can repeat the code as many times as needed. Your fax machine will take over the call and print the fax message. If your caller wants to talk before sending the fax, you can have a conversation first and then activate your fax machine with the code.

The Remote Activation Code can also be used by your callers. When you are using a TAD, your outgoing message (OGM) should end with the statement **"to send a fax, press *51"**. (See the section on Connecting a Telephone Answering Device for more information.)

Using the Deactivation Code:

When your fax machine is in F/T mode, sometimes it will answer a call that is not fax calling tones (a telephone call or manual fax). It will respond with a **double ring** (short, short) to alert you to take over. Because it has already answered the call, only the fax machine will ring; extension phones are no longer connected to the call. Pick up any phone except external phone on the line.

To take over the call at the fax machine:

Pick up the handset of the fax machine and talk to the caller as usual. If no one is there or someone is trying to send you a manual fax, press the START key and replace the handset. Your fax machine will display "receiving" and print the incoming fax message.

To take over the call at an extension phone:

Pick up the handset on another telephone and **press #51 quickly during the silence between the double ring pattern.** When the fax machine hears the code it will stop ringing and let you speak with the caller. If no one is on the line or someone is trying to send you a manual fax, send the call back to the fax machine (*51).

Making the Remote Codes Easier to Use

You can change the codes at any time. It may be easier for you and your callers to press the same key three times (Example: *** and ###). Although you can change the codes to any numbers you want, try to avoid using digits for the Activation Code. The Remote Activation Code can not match any number you dial. If you try to dial a phone number that includes the Activation Code, your fax machine will go into receiving mode.

Troubleshooting

Sometimes other equipment on your phone line reserves a key that is in the Activation or Deactivation code. (Some answering machines reserve the "*" key.) If the code you use to retrieve messages from your answering machine causes the line to be disconnected, try changing the Remote Codes. Change *51 to ### and #51 to 999. The Remote Activation and Deactivation Codes may not work with some telephone systems or telephone sets.

NOTE: If you accidentally pick up an extension phone when a fax message is being received, you may disrupt the transmission or render some portions unreadable.

Changing and Registering Remote Codes

KEYS TO PRESS

1. Press **FUNCTION**.
2. Press **7**.
3. Press **5**.
4. Press ◀ (left arrow) or ▶ (right arrow) to choose ON or OFF.
Example: ON.
5. Press **SET**.
6. Enter new remote code to activate. (Factory setting is “*51”.) Then wait for 2 seconds.
7. Enter new remote code to deactivate. (Factory setting is “#51”.)
8. Wait for 2 seconds.
9. Press **STOP** to exit.

THE DISPLAY WILL SHOW:

09/12/1996 15:25

1.TEMP.SETTINGS

7.SETUP SYSTEM

5.REMOTE CODE

REMOTE ACT.:ON

SELECT ◀ → & SET

REMOTE ACT.:ON

ACT.CODE:*51

DEACT.CODE:#51

5:REMOTE CODE

C) CONNECTING A TELEPHONE ANSWERING DEVICE (TAD)

The TAD Mode

When you have a Telephone Answering Device on the fax phone line, the TAD will answer all the incoming calls. Your Brother fax machine will listen in on the line for fax CNG tones. If it hears them, it will take over the call and receive the fax message. If it does not hear fax tones, it will let the TAD continue playing the outgoing message so the caller can leave a voice message.

The TAD must answer within 4 rings (2 rings are recommended). The fax machine can not hear the CNG calling tones until the TAD answers the call. With 4 rings, only 8-10 seconds of CNG calling tones are left for the "handshake". So you must strictly follow the instructions for recording the OGM.

You must erase the incoming messages frequently on your TAD. When the TAD's memory is full it will not answer incoming calls (fax or voice).

FOR YOUR INFORMATION

Connecting an External TAD to the Unit

You may connect an external TAD to your fax machine, as shown below. Use the "EXT." jack on your fax machine.

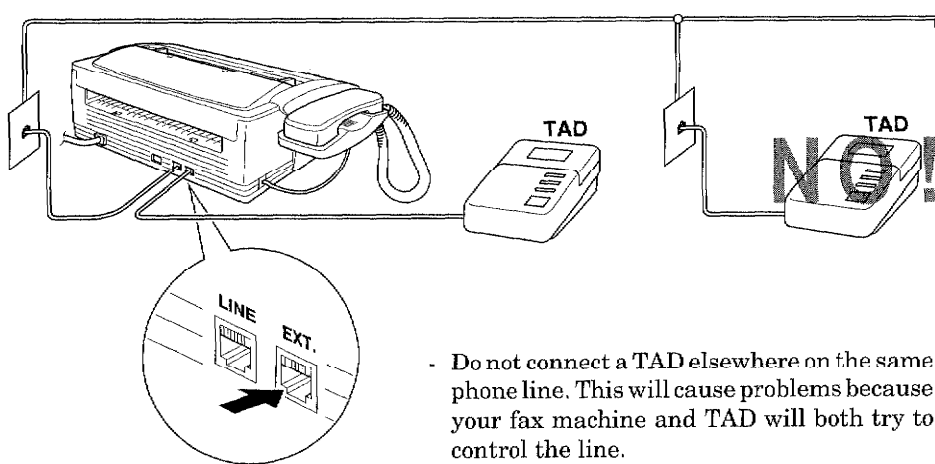

Example of the Sequence of External TAD Reception

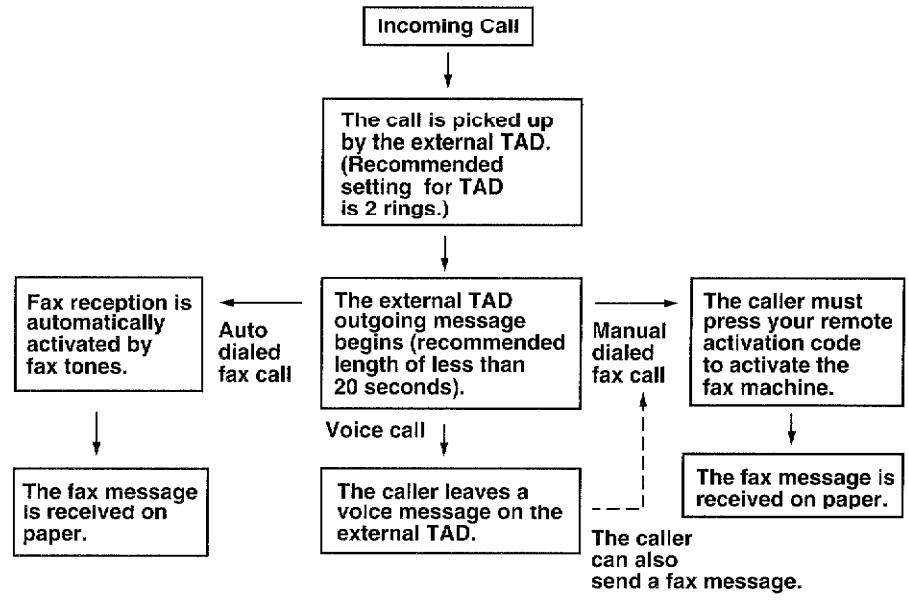

Hookup

There is only one way you can hook up a Telephone Answering Device (TAD) on the fax phone line. **The TAD must be plugged into the back of the fax machine in the jack labeled EXT.** Your fax machine can not work properly if you plug the TAD into a wall jack. Follow these steps:

1. Plug the telephone line cord from the wall jack into the back of the fax machine in the jack labeled **LINE**.
2. Plug the telephone line cord from your TAD into the back of the fax machine in the jack labeled **EXT**. (Double check that the telephone line cord comes from the jack in the TAD for telephone line and not for telephone set.)
3. Put your fax machine in TAD mode by turning both the AUTO and F/T lights on.
4. Set your TAD to 4 rings or less. (The fax machine's Ring Delay setting does not apply).
5. Turn the TAD's Answer mode to **ON**.
6. **Record the OGM** (outgoing message) on your TAD as explained below.

Ch. 7

Recording the TAD's Outgoing Message (OGM)

The TAD's outgoing message is important because it must be set up to handle two kinds of fax receptions: automatic and manual. Timing is important.

1. Record 5 seconds of silence as the beginning of your message. (Your fax machine will be able to hear the fax calling tones, of automatic fax transmissions, before they stop.)
2. Limit your speaking to 20 seconds.
3. End your 20 second message by giving your Remote Activation Code for people sending manual faxes:
"After the beep, leave a message or send a fax by pressing *51."

NOTE: Do not assume that most callers send faxes automatically. Many people do not realize they are not sending fax tones when they lift the handset or press HOOK. Also, some machines may not send fax tones.

D) DISTINCTIVE RINGING

Distinctive Ringing

What Is Distinctive Ringing?

Distinctive ringing is a service offered by the telephone carriers that allows you to have several different numbers on one phone line, each with its own distinctive ringing pattern. This way, when you get an incoming call, you can identify the number being called by its ring. Your local telephone company can provide more information about this service. The service is usually offered as a monthly charge to your normal telephone bill.

Can My Fax Machine Use Distinctive Ringing?

Yes, it has a distinctive ringing function that allows you to register the distinctive ringing pattern of an additional phone number on the line. The number you register must be the number you want to use as your dedicated fax number. Once you register the ringing pattern, the fax machine will be able to identify its own incoming calls and automatically receive faxes at that number. You can register only one ringing pattern. There are some ringing patterns that can not be registered.

Can I Change the Setting Later?

Yes, you can change or cancel the distinctive ringing setting at any time. You can switch it OFF temporarily and then turn it back ON. When you move or get a new fax number, change the distinctive ringing mode to SET so you can register the new number.

How Will the Fax Machine Treat All Other Numbers?

As long as the fax machine is set to **MANUAL** mode and you have registered its distinctive ringing number, **the fax machine will answer only the registered number**. When a call comes in to your main number (or additional distinctive ringing numbers), all the phones will ring until you or an answering machine pick up the call. (See the chart on page 7-13.)

If you want the fax machine to allow a telephone answering device (TAD) to answer only the main number(s), you must leave the fax machine in **MANUAL** mode. You can plug the telephone answering device into either the **EXT** jack of the fax machine or into a separate phone jack. If the TAD is in the **EXT** jack, you will not hear the first two rings on the TAD. The TAD must be set to its maximum number of rings (at least 4 ring cycles). Otherwise, it will answer the registered distinctive ringing number before the fax machine has time to recognize the ringing pattern.

If you change the answer mode on the fax machine to **AUTO** or **F/T**, that setting will override the Distinctive Ringing setup. **In AUTO or FT modes, your fax machine will answer all the phone numbers (including its own ring pattern).**

How Does the Distinctive Ringing Function Work?

Your telephone number will have the standard ring pattern of long long, while the new number could have a ring pattern of short short, long short, etc. When Distinctive Ringing is ON, you will not hear the first two rings of all incoming calls on the fax machine. Extension phones will ring as usual. If the fax machine recognizes the ring pattern, all ringing will stop and the fax machine will answer and automatically receive the fax message. Otherwise, you will hear the extension phones and the fax machine continue to ring. The fax machine always listens to at least two ring patterns before it answers, so do not pick up the phone during that time. You will quickly learn to recognize the ring pattern for faxes, so you will not be tempted to answer that number. Either you or a telephone answering device can answer the main number(s).

Flowchart Sequence of an Incoming Call

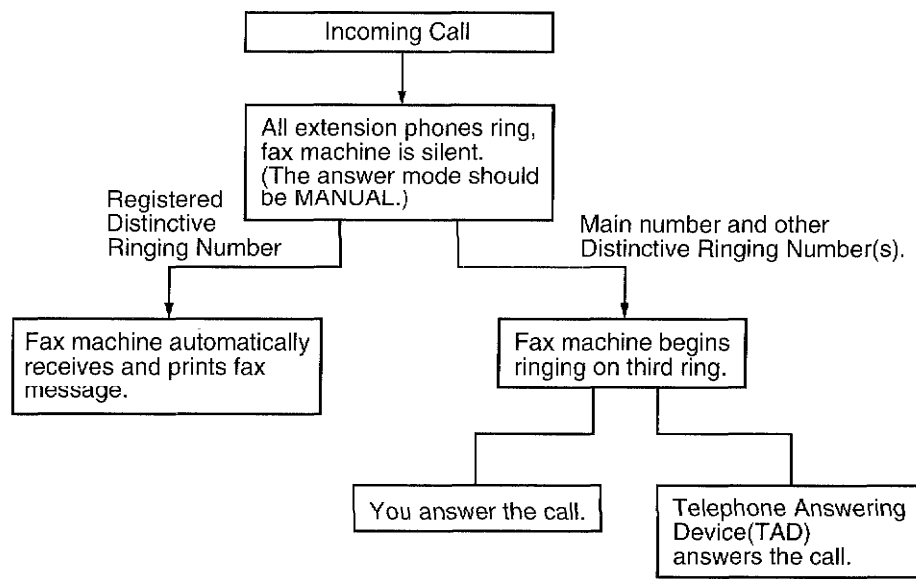

Ch. 7

What is the Advantage of Using the Distinctive Ringing Function?

Using Distinctive Ringing is the most efficient way to receive both fax and telephone calls on the same line. It is much easier for your callers who dial manually. The fax machine will answer with receiving tones so they will not have to press an activation code (TAD mode) or wait 30 seconds to hear fax tones (F/T mode). And the people who call to talk on your main number, will not have to talk to your fax machine. Basically, it gives you two independent numbers without the higher cost of a second line.

Which Phone Number Should I Register?

It is a good idea to keep your old number for its original purpose and to register the new number as your fax number. Remember to give the new fax number to your customers and colleagues.

What Must I Do to Set up Distinctive Ringing?

To use the Distinctive Ringing feature you must:

1. Get the distinctive ringing service from your telephone carrier.
2. When your distinctive ringing number is available, register it in the function called Setting the Distinctive Ringing Function.
3. Keep the fax machine in MANUAL answer mode (both AUTO and F/T lights turned off.)

Setting the Distinctive Ringing Function

This function is a one-time procedure to register a distinctive ringing number with your fax machine. Your fax machine will answer the registered number automatically, simulating AUTO answer mode on a dedicated fax line. You can register **only** one number. **Do not try to set up this function if you do not have the distinctive ringing service. It may cause your fax machine to malfunction.**

This procedure is in two parts: First, you must put the fax machine in SET mode; D/R SET MODE will be on the display screen. Second, you must wait for your friend to call the distinctive ringing number so you can register the ringing pattern. When a call comes in, do not pick up the handset until the fax display says PICK UP TO SET. Then pick up the fax handset. If the caller dialed your distinctive ringing number, press START and check that the display says REGISTERED before you hang up. If the caller dialed the other number, press STOP and hang up to try again.

Before you begin this function:

1. If you have a telephone answering device, **unplug** it until after you have finished registering the distinctive ringing number.
2. **Have a friend ready to call your distinctive ringing number.**

After you complete this one-time setup:

1. The Distinctive Ringing function automatically will be changed from SET to ON. **Distinctive Ringing operates in MANUAL mode, so you must keep the AUTO and F/T lights turned off.**
2. Be sure to have your friend call you on **both** numbers to test that everything is set up correctly.
3. If you do not complete this function by pressing START to register a number, your machine will stay in MANUAL mode. So, if you decide **not** to register a number, you must repeat Steps 1-6 and in Step 4 change the mode to OFF.

KEYS TO PRESS

1. Press **FUNCTION**.
2. Press **6**.
3. Press **6**.
4. Press ◀ (left arrow) or ▶ (right arrow) to find the SET mode.
5. Press **SET**.

THE DISPLAY WILL SHOW:

09/12/1996 15:25

1. TEMP. SETTINGS

6. TEL OPTIONS

6. DISTINCTIVE

DISTINCTIVE: OFF

SELECT ◀ ▶ & SET

DISTINCTIVE: SET

6. Press **STOP**.

NOTE: The display should say **D/R SET MODE**. Also, the answer mode lights will flash. You must now wait for someone to call the distinctive ringing fax number.

6. DISTINCTIVE

D/R SET MODE

7. When the phone rings, listen carefully to check that the ringing pattern is the one you want to register. If it is, wait (at least two ring cycles) until the display says **PICK UP TO SET**. Then pick up the fax handset.

PICK UP TO SET

START TO SET
STOP TO CANCEL

8. Press **START** to set.

Check that the display says **REGISTERED**.

(If the other number was called, press **STOP** to cancel.)

REGISTERED

9. Hang up the handset.

How to Turn the Distinctive Ringing Function ON or OFF

The distinctive ringing function is designed to accommodate the distinctive ringing service (a telephone service that provides you with a multiple numbers, each with a distinctive ring pattern, on one line). You can change the distinctive ringing function setting to ON or OFF as needed after you have registered the distinctive ringing number in the function called Setting the Distinctive Ringing Function. To change the setting, repeat Steps 1-6; Step 4 is where you can select either ON or OFF.

Ch. 7

E) CALLER ID (Only for FAX-675/715M/725M)***What is Caller ID?***

Caller ID is a telephone service that allows the subscriber to see a display of the caller's phone number (and name in certain states) as the telephone rings. It is a fast way to screen your calls. You can respond quickly to calls you missed, because Caller IDs are received and stored in your machine's memory.

NOTICE

To get the Caller ID Service: apply for the Caller ID service at your local telephone company.

The type of service varies from state to state and is determined by your telephone company. Your particular service may display only the caller's phone number or the caller's number and name.

Advantages of Caller ID

For Business

All businesses profit from a quicker response to customer calls. Businesses that provide mail order services, money-lending services or provide confidential information, can protect themselves from false orders or acceptance of false identification.

At Home

Residential customers can protect themselves from unwanted calls.

How Does the Caller ID Work?

The Caller ID Appears on the Display When Your Telephone Rings

As your telephone rings, the display shows you the caller's phone number (or caller's name in certain states). You will know who is calling before you pick up the handset or before your machine automatically receives the call. Once you pick up the handset, the caller's ID disappears. If both the caller's phone number and name are received, only the name will appear on the display. You will see the first 16 characters of the number or name.

- Helpful Hints**
- If "OUT OF AREA" appears on the display, it means that the call came from outside your caller ID service area.
 - If "PRIVATE CALL" appears on the display, it means the caller intentionally blocked the transmission of his/her ID.
 - If no caller ID was transmitted to your fax machine, "CALL PICKUP" will remain on the display.

The Caller ID is Stored in Your Machine's Memory (Only for FAX-715M/725M)

The machine can store a maximum of the last 30 incoming caller IDs in the memory, along with the time and date of reception. The 31st call will cause the oldest ID to be erased.

The Caller ID information stored in the memory can be scrolled through on the display.

And you can also print the Caller ID list and review calls you received by checking the Caller IDs (see page 7-18). This report will list the Date, Time, Phone Number (Caller ID), Name (in certain states), and type of call (Comment). On FAX-675, you can use the Activity Report, which lists the last 30 transactions (see page 10-3). The Activity Report usually lists only fax calls (incoming and outgoing). However, if you are using Caller ID, the Caller ID information for incoming fax calls will be included.

NOTE: Please set up the number of rings to more than 02 in the Ring Delay (See page 7-2) before you use the Caller ID. If you set up the number of rings to 01, you can not receive the Caller ID.

Scanning through a Caller ID in the Memory (Only for FAX-715M/725M)

You can display the caller IDs that are stored in the memory to see who called you. (You can skip to Step 4 below by pressing the **SHIFT** and **TEL INDEX** keys simultaneously.)

KEYS TO PRESS

1. Press **FUNCTION**.
2. Press **6**.
3. Press **7**.
4. Press **SET**.

The Caller ID of the last call will appear on the display.

- If no ID is stored, the beeper will sound and "NO CALLER ID" will appear on the display.

5. Press ◀ (left arrow) or ▶ (right arrow) key to scroll through the Caller IDs in the memory.

In this example, press the ▶ key 5 times.

- Pressing the ▶ key will cycle backward through the stored caller IDs from the latest to the oldest. If you press the ▶ key when the oldest ID appears, the latest one will appear. The ◀ key cycles forward.

- After 2 seconds, the date and time the caller ID was received will appear.

6. Press **STOP** to exit.

THE DISPLAY WILL SHOW:

09/12/1996 15:25
 1. TEMP. SETTINGS
 6. TEL OPTIONS
 7. CALLER ID
 30)1415551212

25)5555151

09/11/1996 21:02

FOR YOUR INFORMATION

Clearing the Caller ID stored in Memory

For the effective use of the memory, it is recommended that you clear the Caller ID stored into memory by pressing **CLEAR** when the display shows the number or name.

Printing the Caller ID List (Only for FAX-715M/725M)

You can print a listing of the Caller IDs for the last 30 calls received. Both telephone and fax calls will be listed. You can check the Caller IDs on the Activity Report (see page 10-3) on FAX-675.

KEYS TO PRESS

1. Press **FUNCTION**.
2. Press **3**.
3. Press **9**.
4. Press **SET**

Wait 2 seconds until you see the prompt at the right.

5. Press **START**.

THE DISPLAY WILL SHOW:

09/12/1996 15:25

1. TEMP. SETTINGS

3. PRINT REPORTS

9. CALLER ID

PRESS START KEY

PRINTING

▼ **Sample of Caller ID List**

CALLER ID LIST					
TIME : 09/04/1996 14:05					
NAME : BROTHER					
FAX : 415554444					
TEL : 415554445					
	①		②	③	④
	DATE	TIME	CALLER ID	NAME	COMMENT
01	09/04	13:03	908 322 1212	JOHN GEORDAN	TEL RX
02	09/04	13:04	908 322 1212	JOHN GEORDAN	TEL
03	09/04	13:08	911 555 0000	SMITH SHARON	TEL RX
04	09/04	13:10	912 555 5711	KIM DOBECK	RX
05	09/04	13:22	981 555 0101	JONES JENNIFER	
06	09/04	13:33	981 555 0101	JONES JENNIFER	
07	09/04	13:37	911 555 0000	SMITH SHARON	TEL RX
08	09/04	13:45	908 322 1212	JOHN GEORDAN	TEL TX
09	09/04	13:57	912 555 5711	KIM DOBECK	RX
10	09/04	14:00	911 555 0000	SMITH SHARON	TX
11	09/04	14:01	981 555 0101	JONES JENNIFER	RX

(Sample List of FAX-715M/725M)

NOTE: "TX" means Transmit, "RX" means Receive.

CONTENTS OF THE LIST:

- DATE & TIME ①
- CALLER ID ②
- NAME (ONLY WHEN AVAILABLE) ③
- COMMENT ④

COMMENTS WILL INCLUDE:

- TX means your machine sent a fax message when it was polled or called.
- RX means your machine received a fax message (except polling and calling receiving).
- TEL means you answered a telephone call at your fax machine, external TAD or external phone.
- BLANK means the call was not answered or you answered at an extension phone.

8. POLLING

FOR YOUR INFORMATION

What Is Polling?

Polling is the process of **retrieving** faxes from another fax machine. You may use your machine to “poll” other machines, or you may ask someone to poll your machine. The party who polls pays for the cost of the call.

How Does It Work?

First all parties set up their fax machines so that they can accommodate polling. Then one party leaves documents in the fax machine so that the other party can call and have the documents sent to them.

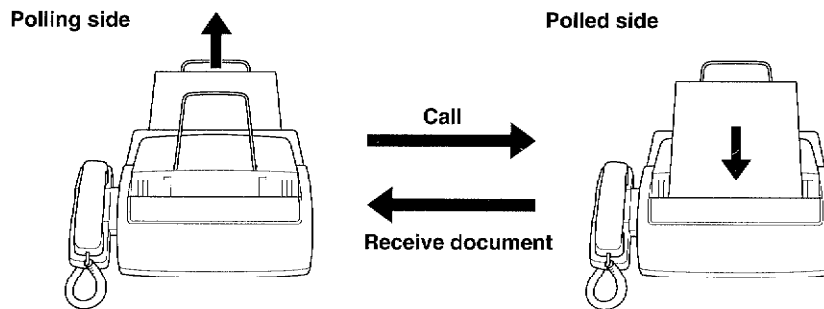

When to Use Polling?

Use polling to control the cost of who pays for sending a fax.

1. If **you** want to pay for the cost of the call: Send faxes to other parties as you normally would, and if another party has documents to send you, ask if you can poll for them.
2. If you want **others** to pay for the cost of the call: Ask them to poll your fax machine for documents they want, and have them fax any documents that you want.

* There are some fax machines that will not respond to the polling function.

Helpful Hints Using Polling Effectively (Examples)

Problem No. 1: You want another party to send you a long fax, but they do not want to pay for the call.

Solution: Ask them to leave the document in their fax machine so you can poll for it.

Problem No. 2: Sales representatives have difficulty sending faxes to the head office's fax machine because it is busy so much of the time.

Solution: Head office can poll the sales representatives' fax machines.

Problem No. 3: Because of the time or location, it is cheaper for someone else to call you than it is for you to make the call.

Solution: Ask the other party to poll for the documents and offer to pay for the call at their lower rate.

Polling Another Fax Machine (Calling)

Once you have set up polling, as described below, and the other party has set their fax machine to "POLLED WAITING", you can receive their documents automatically.

KEYS TO PRESS

Make sure there are no documents in your feeder.

1. Press **FUNCTION**.
2. Press **1**.
3. Press **2**.
4. Wait for two seconds.
5. Press **SET**.
6. Press **STOP**.
7. Enter the fax number.
Example: One-touch dialing.
8. Press **START**.

THE DISPLAY WILL SHOW:

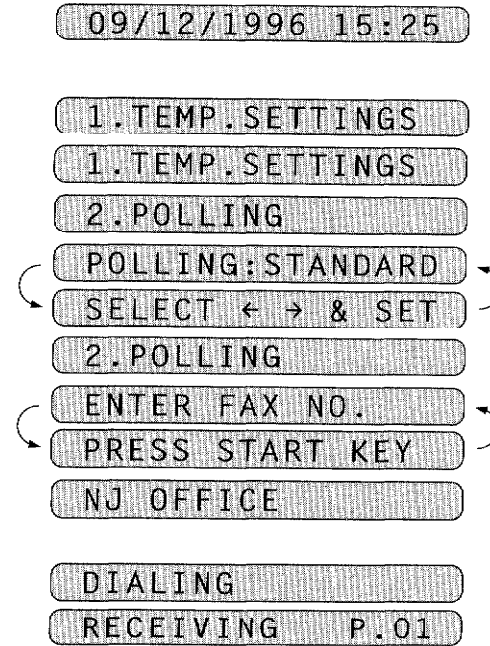

Setting up Polled Waiting (Being Called)

Polled Waiting is when you place a document in your fax machine and set your machine to allow another fax machine to retrieve that document. Your fax machine will print a Polled Report after the transmission.

KEYS TO PRESS

1. Place the documents into the feeder.
2. Press **FUNCTION**.
3. Press **1**.
4. Press **2**.
5. Wait for two seconds.
6. Press **SET**.

THE DISPLAY WILL SHOW:

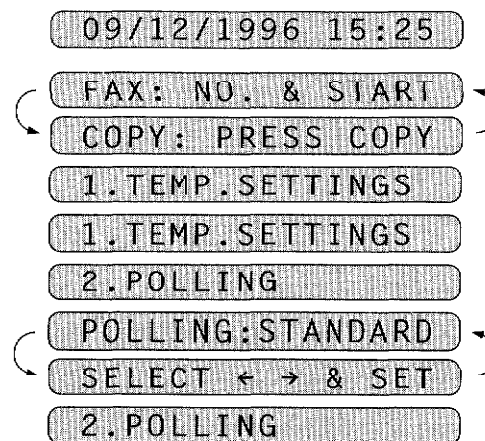

7. Press **STOP**.
8. Press **START** and wait for the polling call to come in.

PRESS START KEY
 POLLED WAITING

Secure Polling

Secure Polling is a way to keep your documents and others' from falling into unauthorized hands while the fax machines are set up for polling. You can use Secure Polling only with another Brother fax machine. Your four-digit ID number must be entered on the fax machine that polls for your documents.

Polling Another Brother Fax Machine with Secure Code (Calling)

You can poll another Brother fax machine that has Secure Polling by following the steps below: You need to make sure you are using the same ID number as the other party.

KEYS TO PRESS

Make sure no documents are in the feeder.

1. Press **FUNCTION**.
2. Press **1**.
3. Press **2**.
4. Wait for two seconds.
5. Press ◀ (left arrow) or ▶ (right arrow) to find the POLLING SECURE setting.
6. Press **SET**.
7. Enter a four-digit number. This is the security code of the fax machine you are polling.
Example: **1234**.
8. Wait for two seconds.
9. Press **STOP**.
10. Enter the fax number.
Example: One-Touch dialing.
11. Press **START**.

THE DISPLAY WILL SHOW:

09/12/1996 15:25
 1. TEMP. SETTINGS
 1. TEMP. SETTINGS
 2. POLLING
 POLLING: STANDARD
 SELECT ← → & SET
 POLLING: SECURE
 POLLING ID: XXXX
 POLLING ID: 1234
 2. POLLING
 ENTER FAX NO.
 PRESS START KEY
 NJ OFFICE
 DIALING
 RECEIVING P. 01

Setting up Polled Waiting with Secure Polling (Being Called)

Secure Polling allows you to create a Polling ID number to protect your documents during polled waiting mode. Anyone who polls your machine must enter this polling ID number.

KEYS TO PRESS

1. Insert the documents into the feeder.
2. Press **FUNCTION**.
3. Press **1**.
4. Press **2**.
5. Wait for two seconds.
6. Press ◀ (left arrow) or ▶ (right arrow) to find the **POLLING SECURE** setting.
7. Press **SET**.
8. Enter a four-digit number.
Example: **1234**.
9. Wait for two seconds.
10. Press **STOP**.
11. Press **START** and wait for the polling call to come in.

THE DISPLAY WILL SHOW:

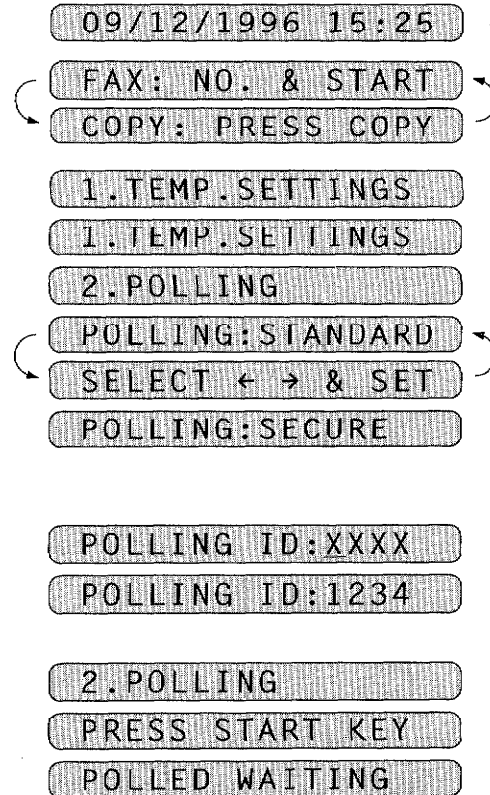

Delayed Polling

You can set the time when you want the polling to take place. After you select STANDARD or SECURE, press **SET**, then press **1** and use the number keys to enter the time when you want polling to take place.

KEYS TO PRESS

Make sure no documents are in the feeder.

1. Press **FUNCTION**.
2. Press **1**.
3. Press **2**.
4. Wait for two seconds.
5. Press ◀ (left arrow) or ▶ (right arrow) to select **STANDARD** or **SECURE**.
Example: **STANDARD**.
- If you select **SECURE**, remember to give your password to the other party.
6. Press **SET**.
7. Press **1**.
8. Enter the time.
Example: **19:45** (7:45 P.M.).
9. Wait for two seconds.
10. Press **STOP**.
11. Enter the fax number.
Example: One-touch dialing.
12. Press **START**.
The fax machine will wait until the specified time to call.

THE DISPLAY WILL SHOW:

09/12/1996 15:25

1. TEMP. SETTINGS

1. TEMP. SETTINGS

2. POLLING

POLLING: STANDARD

SELECT ◀ ▶ & SET

POLLING: STANDARD

2. POLLING

1. TIMER

SET TIME=00:00

SET TIME=19:45

1. TIMER

ENTER FAX NO.

PRESS START KEY

NJ OFFICE

09/12/1996 15:25

Setting up Polled Waiting with Quick-Scan (Only for FAX-715M/725M)

Before pressing **START**, press **Q.SCAN** so that you can store your polled waiting document in the memory.

Helpful Hints If you use **Q.SCAN** to place the Polled Waiting documents into the memory, they will not be erased automatically after they are polled. To erase them you must use the Cancel Job function. (See page 6-11.)

9. HOW TO USE COPY FUNCTIONS

Making a Single Copy

When you want to make a copy, make sure the text or image on the original document is not too close to the edge. Your fax machine cannot read anything closer than 4 mm (1/8 inch) from the edge.

You can select the resolution to either SUPERFINE or PHOTO. Set the resolution to either one. If you do not set the resolution, the fax machine automatically makes a copy at SUPERFINE resolution. For example, if your original is a photo, you may select PHOTO resolution. (To get PHOTO resolution, press **RESOLUTION** repeatedly until both lights are lit.) You can also set the resolution page by page using the 1. TEMP. SETTINGS function. (See page 6-12~13.)

Do not pull on the paper while copying is in progress. This may distort the copied image and damage your machine.

These are the steps for making one copy each of your original documents:

KEYS TO PRESS

1. Place the documents face down into the fax machine.
2. Press **COPY**.
3. Press **COPY**, again for a quicker response. Or after 5 seconds, the copying will start.

THE DISPLAY WILL SHOW:

09/12/1996 15:25

FAX: NO. & START

COPY: PRESS COPY

NO. OF COPIES: 01

ENTER & COPY KEY

COPYING

COPYING P.01

COPYING P.02

HOW TO USE COPY FUNCTIONS

Making Multiple Copies (Only for FAX-715M/725M)

There are two ways to make multiple copies on your fax machine. The first is the stacking method, this will make n copies of page one, n copies of page two and so on. These will all be stacked on top of each other. The second method is the sorting or collating method. This is when the fax machine scans the entire document and then makes 1 copy of page 1, 2, 3, 4 in order. Then makes a second copy of 1, 2, 3, 4 until a total of n copies has been made.

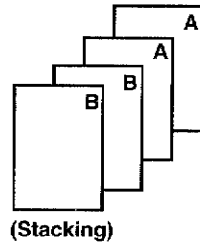

(Stacking)

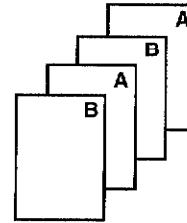

(Sorting)

KEYS TO PRESS

1. Place the documents face down into the feeder.
2. Press **COPY**.
3. Enter two digits for the number of copies you want using the number keys (Max. 99 copies).
Example: 05.
4. Press **COPY** or just wait 5 seconds.
5. Press ◀ (left arrow) or ▶ (right arrow) to select the stacking or sorting method.
Example: STACK.
6. Press **COPY** to begin copying.

THE DISPLAY WILL SHOW:

09/12/1996 15:25

FAX: NO. & START

COPY: PRESS COPY

NO.OF COPIES:01

ENTER & COPY KEY

NO.OF COPIES:05

MULTI COPY:STACK

SELECT ↔ & COPY

MULTI COPY:STACK

COPY STACK P.01

- NOTE: 1. When making Multiple Copies, do not let the receiving tray become overstacked. Remove copied paper from the receiving tray frequently.
2. When making Multiple Copies, make sure there is enough recording paper in the machine.

FOR YOUR INFORMATION

What to Do When You Get a "MEMORY FULL" Message while Making Copies

If you are using the stacking method, press **STOP**. If you are using the sorting method, press **COPY** to copy the portion that is in the memory, or press **STOP** to cancel.

10. PRINTING REPORTS AND LISTS

You can print the following lists and reports under function item 3. PRINT REPORTS.

Level one function	Level two function	Content	Page
3. PRINT REPORTS	1. ACT. REPORT	The Activity Report lets you know if transmissions and incoming faxes were received.	10-3
	2. ALL DIAL	This is a list of the names and numbers that are stored in One-Touch and Speed-Dial memory, printed in One-Touch and Speed-Dial number order.	10-3~4
	3. TEL. INDEX (Only for FAX-715M/725M)	This report is same as the All Dial list printed in alphabetical order.	_____
	4. COVERPAGE (3. on FAX-615/625/635/675)	This report allows you to check the Cover Page format.	6-14
	5. CALL BACK MSG (4. on FAX-615/625/635/675)	This report is used to check the Call Back message format.	6-19
	6. USER OPTIONS (5. on FAX-615/625/635/675)	The settings for FUNCTION 5 to 7 (USER OPTIONS, TELOPTIONS and SETUP SYSTEM) are printed here.	_____
	7. XMIT REPORT (6. on FAX-615/625/635/675)	You can choose whether the Transmission Verification Report will be printed after all faxes you send. ON/OFF	10-5
	8. MEMORY STATUS (Only for FAX-715M/725M)	The addressee and the amount of occupied memory for items stored in the memory are printed here.	10-5
	9. CALLER ID (Only for FAX-715M/725M)	You can review calls you received by checking this list.	7-18

Other Reports

The following reports are printed automatically, for your information.

- Help List (By pressing **HELP** on the control panel.) (See page 3-7.)
- Polled Report
- Delayed Sending Report
- Broadcast Report (Only for FAX-715M/725M)
- Transmission Verification Report

- Helpful Hints**
- If you need an ACS check sheet, press ◀ (left arrow) and ▶ (right arrow) simultaneously.
 - If you press ◀ (left arrow) and ▶ (right arrow) simultaneously again, an ACS check sheet will not be printed.

PRINTING REPORTS AND LISTS

All the reports and lists may be printed as follows:

KEYS TO PRESS

1. Press **FUNCTION**.
2. Press **3**.
3. Press the number of the level two function you wish to print.
Example: 1.ACT.REPORT.
4. Press **START**.

THE DISPLAY WILL SHOW:

09/12/1996 15:25

1.TEMP.SETTINGS

3.PRINT REPORTS

1.ACT.REPORT

PRESS START KEY

PRINTING

Activity Report Interval

An Activity Report can be printed at certain intervals that you specify. You can set the journal period to "OFF", "6 hours", "12 hours", "24 hours", "2 days", "4 days" or "7 days". The Activity Report will list all outgoing and incoming faxes (only the last 30) during that period. The factory default setting is OFF.

After the Activity Report has printed at the preset interval, the information will be deleted and can not be recovered. However, at any time between these scheduled reports, you can manually print the Activity Report and the information will remain.

NOTE: If your Activity Report is not listing all your transactions, select a shorter interval period.

KEYS TO PRESS

1. Press **FUNCTION**.
2. Press **7**.
3. Press **3**.
4. Press ◀ (left arrow) or ▶ (right arrow) to choose the setting.
Example: 12 HOURS.
If you select seven days, you should choose the base day of the week.
5. Press **SET**.
6. Enter the time to print in 24-hour format using the number keys.
Example: **19:45** (7:45P.M.).
7. Wait for two seconds.
8. Press **STOP** to exit.

THE DISPLAY WILL SHOW:

09/12/1996 15:25

1.TEMP.SETTINGS

7.SETUP SYSTEM

3.INTERVAL

ACT.RPT.:OFF

SELECT ◀ ▶ & SET

EVERY 12 HOURS

START AT:00:00

START AT:19:45

3.INTERVAL

ACTIVITY REPORT						
						TIME : 09/12/1996 19:45
						NAME : BROTHER
						FAX : 4155554444
						TEL : 4155554445
DATE	TIME	FAX NO./NAME	DURATION	PAGE(S)	RESULT	COMMENT
09/12	10:00	BROTHER BOSTON	04:23	20 CV CA	OK	IX
09/12	10:10	NJ OFFICE *	00	00	ERROR	RX
09/12	15:53	BROTHER BOSTON	48	01 CV CA	OK	TX ECM
CV : COVERPAGE CA : CALL BACK MSG POL : POLLING * : CALLER ID						

(Sample list with Caller ID information for FAX-675)

NOTE: "TX" means Transmit, "RX" means Receive.

COMMENTS WILL INCLUDE:

- TX means your machine sent a fax message when it was polled or called.
- RX means your machine received a fax message (except polling and calling receiving).
- TEL means you answered a telephone call at your fax machine, external TAD or external phone.
- BLANK means the call was not answered or you answered at an extension phone.

Printing the All Dial List

You can print a list of all One-Touch numbers and Speed-Dial numbers.

ALL DIAL LIST			
			TIME : 09/12/1996 15:25
			NAME : BROTHER
			FAX : 4155554444
			TEL : 4155554445
ONE-TOUCH DIAL			
NUMBER	FAX/TEL NUMBER		DESTINATION
*01	61-2018285881	FAX	AUSTRIAN OFFICE
*02	234-5678	TEL	ABC COMPANY
*03	334-5566	FAX	HEAD OFFICE
*04			
*05	14155551212	FAX	NJ OFFICE
*20			
@:CHAIN			

PRINTING REPORTS AND LISTS

ALL DIAL LIST				
SPEED-DIAL		TIME : 09/12/1996 15:25		
		NAME : BROTHER		
		FAX : 4155554444		
		TEL : 4155554445		
NUMBER	FAX/TEL NUMBER		DESTINATION	GROUP
#01	5892786	F/T	BROWNE M.	
#02@	1234567		W. COMPANY	
#03	03-256-1121	FAX	TOKYO OFFICE	
#40	5555151	TEL	MANCHESTER	

@:CHAIN

(ALL DIAL LIST of FAX-725M)

Transmission Verification (Xmit) Report

The Transmission Verification Report can be used as proof that you sent a fax. It lists the name or fax number of the receiving party, the time and date of transmission, and whether the transmission was successful. The factory default setting is OFF.

OFF: The report will be printed automatically only if an error occurs during transmission. If the report says "Result: NG" then send all the pages again. If the report says "Result: Check readability of transmitted page(s) 02, 05" then send only pages 2 and 5 again.

ON: A report will be printed automatically. It is important to read the result of each report to check that the transmission was successful.

KEYS TO PRESS

1. Press **FUNCTION**.
2. Press **3**.
3. Press **7**.
(Press **6** on FAX-615/625/635/675.)
4. Press **◀** (left arrow) or **▶** (right arrow) to choose the setting.
Example: ON.
5. Press **SET**.
6. Press **STOP** to exit.

THE DISPLAY WILL SHOW:

09/12/1996 15:25

1. TEMP. SETTINGS

3. PRINT REPORTS

7. XMIT REPORT

XMIT REPORT: OFF

SELECT ◀ ▶ & SET

XMIT REPORT: ON

7. XMIT REPORT

Helpful Hints When you set the transmission Verification Report to ON, the Delayed Transmission Report and the Polled Report will be turned ON also. When the Transmission Verification Report is OFF, the Delayed Transmission Report and Polled Report will print only if an error occurs.

TRANSMISSION VERIFICATION REPORT

TIME : 09/12/1996 15:25
 NAME : BROTHER
 FAX : 4155554444
 TEL : 4155554445

DATE, TIME	09/12 15:24
FAX NO./NAME	NJ OFFICE
DURATION	00:00:45
PAGE(S)	01
	COVERPAGE
RESULT	OK
MODE	STANDARD

Memory Status List (Only for FAX-715M/725M)

The MEMORY STATUS LIST will show you the addressee and amount of occupied memory for items stored in the memory such as delayed transmissions and polled waiting.

MEMORY STATUS LIST

TIME : 09/12/1996 15:25
 NAME : BROTHER
 FAX : 4155554444
 TEL : 4155554445

MEMORY USED FOR FAX FEATURES

	TIME	DESTINATION	#	OF	PAGES
TIMER	1) 18:00	14155551212	01		10%
	2) 23:45	(BROADCAST)	02		20%
POLLING WAITING			01		12%
REDIAL WAITING	1)	BROTHER BOSTON	01		05%
ECM					24%

MEMORY AVAILABLE

FREE	29%
------	-----

(MEMORY STATUS LIST of FAX-725M)

11. REGULAR MAINTENANCE AND TROUBLESHOOTING

Cleaning

You can keep the high printing quality of your fax machine by cleaning it on a regular basis. Avoid using thinners or other organic solvents to clean the machine and do not use water.

Follow the steps below:

1. Unplug the telephone line and then the power cord.
When you reconnect these lines later, make sure to connect the power cord first, then the telephone line.
2. Clean the white bar above.
 - 1) Put your finger under the \triangle mark where there is a groove and lift up the front cover. It should "lock" into an open position.
 - 2) Moisten a small piece of soft, lint-free cloth with isopropyl alcohol and carefully remove any dirt from the white bar of the scanner.

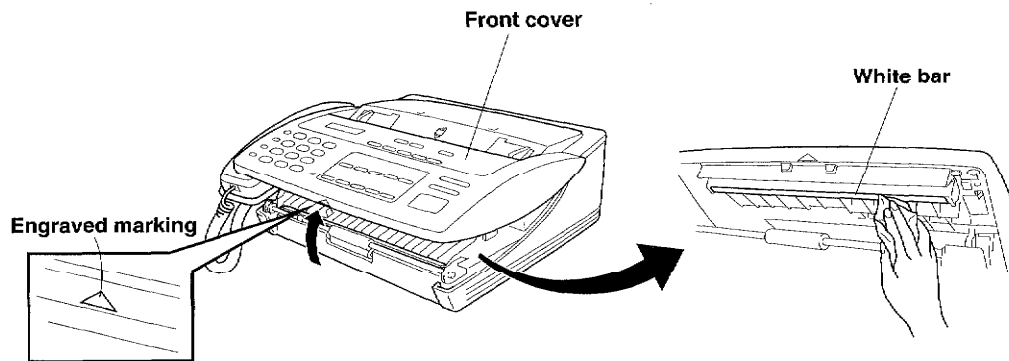

Paper Jams

Your fax machine will sound an alarm if the documents jam while going through the feeder or if the fax paper becomes stuck. The display will show “DOCUMENT JAM”, “CUTTER JAM”, or “PRINTER JAM”.

Fixing a Document Jam

1. Open the front cover.
2. Pull the documents toward the front of the fax machine in the direction they were feeding.
3. Close the front cover.
4. Press **STOP** to clear the jam.

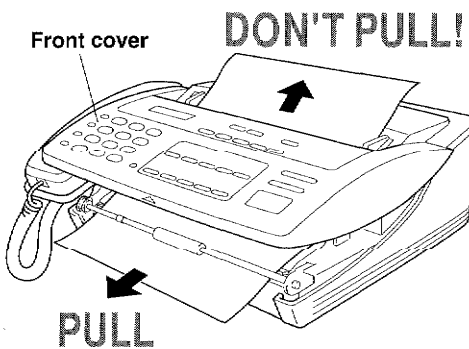

NOTICE

When you have a document jam, do not try to pull the documents back out. The documents should be pulled from the front in the direction they feed through the fax machine. Remember: Pull it out, don't back up!

REGULAR MAINTENANCE AND TROUBLESHOOTING

Fixing a Cutter Jam or Printer Jam

1. Unplug the power cord and open the machine's top cover by lifting it at the grooves. Pull the release lever (blue) on the print head unit and raise it.
2. Use a pair of scissors to cut off the wrinkled portion of the paper.

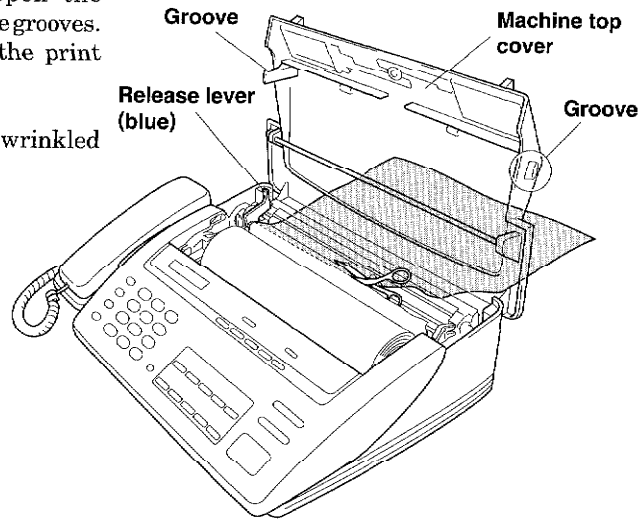

3. Pull the wrinkled paper out from the front or rear side.

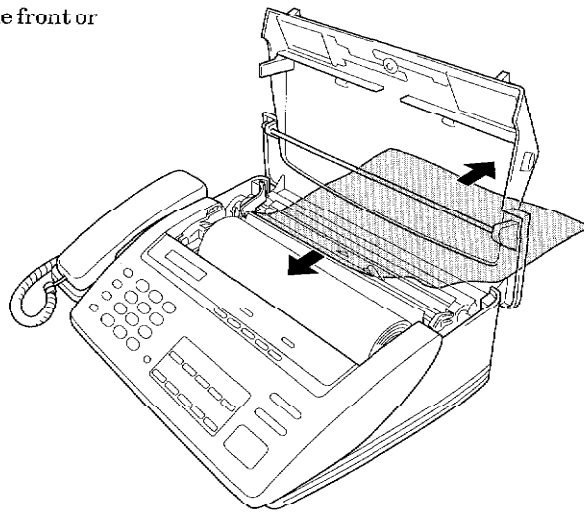

4. Plug in the fax machine.
5. Load the fax paper again and push the release lever (blue) down. Then close the machine's top cover.

Troubleshooting

You may occasionally encounter a problem with your fax machine or telephone line. If this happens, your fax machine often identifies the problem and displays an error message. Refer to the following list when you see an error message on the display. If additional help is needed, please contact the following Customer Service numbers :

U.S.A **1-800-284-4FAX (4329)**

1-908-356-8880 (Extension 7920)

Canada **1-800-853-6660 (Calling from within Canada 8:00A.M. – 8:00P.M. E.S.T)**

Error Messages

CLEAN UP SCANNER

The scanner is dirty. Clean the scanner. (See page 11-1.)

COMM.ERROR

You encountered a communications error that resulted from a poor quality phone line. Try the call again.

CONNECTION FAIL

You have requested a polling call from another party, but the remote station is not in polled waiting mode.

COVER OPEN

The machine's top cover is not closed completely. Make sure it is closed.

CUTTER JAM

The fax paper is jammed in the cutter. Remove the jammed paper. (See page 11-3.) Then re-insert the fax paper. (See page 1-5.)

DISCONNECTED

The telephone line was disconnected by the other party during the communication. Try calling the other party to see what happened.

DOCUMENT JAM

The documents were not inserted properly, the documents were not fed properly, or the documents were too long. Open the front cover and remove the documents. (See page 11-2.) Close the front cover and re-insert the documents, adjusting the guides on either side of the document. Try sending the fax again.

MACHINE ERROR XX and PRESS STOP KEY

Contact the Customer Service number listed on this page.

NO RESPONSE/BUSY

The number you called does not answer or is busy. You may also have reached a number that is not connected to a fax. Check the number and try again.

NOT REGISTERED

The One-Touch key or Speed-Dial number has no number assigned to it. You need to register a phone number. (See page 4-4~7.)

PAPER ROLL EMPTY

The paper roll is empty. You need to replace it. (See page 1-5.)

PRINTER FAULT

The recording head has overheated. Unplug the power cord and wait for 30 minutes.

PRINTER JAM

The fax paper is jammed in the printer. Remove the jammed paper. (See page 11-3.) Then insert the fax paper again. (See page 1-5.)

SCANNER ERROR

Try to clean the scanner and white bar. (See page 11-1.)

If you still get the scanner error, please contact the customer service numbers listed on page 11-4.

Other Problems

Condensed Print and Horizontal Streaks Cut Off Top and Bottom of Sentences

This is usually caused by a bad connection, interference or static on the phone line. Make a copy. If the copy is fine, the machine is OK. Try to receive from other parties and try your machine on another phone line. Have the phone line checked by the telephone company.

Copies and Received Faxes are Blank (White) Pages

The roll of recording paper is upside down or you are not using thermal fax paper. Scratch both sides of the thermal fax paper and place the side with a black or gray line face up.

Cover Page Comment Always Prints "Please Call"

The Cover Page report is only a sample of the format and always prints "Please Call". The comment you programmed will be generated at the receiving machine.

Dialing Does Not Work

Check for a dial tone. Change TONE/PULSE setting. Check all telephone line connections: telephone line from wall jack to LINE jack on fax machine and make sure curled handset cord is not in EXT jack. Check power cord connection. Send a manual fax (press HOOK or lift handset), wait to hear fax receiving tones and press START.

Enabling/Disabling Anti-Curl Check Sheet

At Date and Time prompt, press the left arrow and right arrow keys at the same time until you hear 3 short beeps. ACS is ON. Press this toggle switch again for opposite setting.

Fax Machine Does Not Answer When Called

Make sure the fax machine is not in MANUAL mode (AUTO and F/T lights out). Check it is in the correct receiving mode for your setup (either AUTO, F/T or TAD). Check for a dial tone. If possible, call your fax machine to hear what is happening.

No Dial Tone on the Handset

Press HOOK. If no dial tone, check telephone line connections at fax machine and wall jack. Connect a regular telephone into the wall jack to see if the phone line is working.

No Response/Busy When Sending a Fax

Check that you have the correct number and dialed it correctly. Try to call the number from a regular telephone to make sure it is in service.

Poor Transmitting Quality

If faxes you send are hard to read at the receiving machine, try changing your resolution to FINE or SUPERFINE. Also, clean your scanner glass cover and white pressure bar.

Vertical Black Lines When Receiving

The recording head on your machine may be dirty or the sender's scanner may be dirty. Make a copy; if it is the same, clean your print head with isopropyl alcohol and a lint-free cloth. The print head is about 9 x 1/2 inches and is gold in color with triangular markings.

Vertical Black Lines When Sending

Make a copy. If the copy is the same, the scanner area is dirty. Lift the front cover and look in the front of the machine in the document path. Use isopropyl alcohol and a lint-free cloth. Clean the glass cover (about 9 x 1/2 inches) below and the white metal or plastic pressure bar (same size and shape) found inside the cover above it.

12. IMPORTANT INFORMATION

Standard Telephone and FCC Notices (Applies only to 120V model)

These notices are in effect on models sold and used in the U.S.A.

This equipment is hearing-aid compatible.

When programming emergency numbers and/or making test calls to emergency numbers:

- Remain on the line and briefly explain to the dispatcher the reason for the call before hanging up.
- Perform such activities in the off-peak hours, such as early morning or late evening.

This equipment complies with Part 68 of FCC Rules. On the rear panel of this equipment is a label that contains, among other information, the FCC Registration Number and Ringer equivalence Number (REN) for this equipment. You must, upon request, provide this information to your telephone company.

You may safely connect this equipment to the telephone network by means of a standard modular jack, USOC RJ11C.

An FCC compliant telephone cord and modular plug is provided with this equipment. This equipment is designed to be connected to the telephone network or premises wiring using a compatible modular jack which is Part 68 compliant.

See 1-3 for details.

The REN is useful to determine the quantity of devices you may connect to your telephone line and still have those devices ring when your telephone number is called. In most, but not all areas, the sum of the RENs of all devices connected to one line should not exceed five (5). To be certain of the number of devices you may connect to your line, as determined by the REN, you should contact your local telephone company to determine the maximum REN for your calling area. If your IntelliFAX615/625/635/675/715M/725M damage the telephone network, the telephone company may discontinue your service temporarily. If possible, they will notify you in advance. But if advanced notice is not practical, you will be notified as soon as possible. You will be informed of your right to file a complaint with the FCC.

Your telephone company may make changes to its facilities, equipment, operations or procedures that could affect the proper functioning of your equipment. If they do, you will be notified in advance to give you an opportunity to maintain uninterrupted telephone service.

If you experience trouble with this IntelliFAX615/625/635/675/715M/725M, please contact the manufacturer's authorized service agency for information on obtaining service or repair. The telephone company may ask that you disconnect this equipment from the network until the problem has been corrected or until you are sure that the equipment is not malfunctioning.

If you are not able to solve a problem with your fax machine, contact Brother service personnel at **1-800-284-4FAX (U.S.A. Only)**.

1-800-284-4329

Warning

For protection against the risk of electrical shock, always disconnect all cables from the wall outlet before servicing, modifying or installing the equipment.

This equipment may not be used on coin service lines provided by the telephone company nor connected to party lines.

This equipment has been tested and found to comply with the limits for a Class B digital device, pursuant to Part 15 of the FCC Rules. These limits are designed to provide reasonable protection against harmful interference in a residential installation. This equipment generates, uses, and can radiate radio frequency energy and, if not installed and used in accordance with the instructions, may cause harmful interference to radio communications. However, there is no guarantee that interference will not occur in a particular installation. If this equipment does cause harmful interference to radio or television reception, which can be determined by turning the equipment off and on, the user is encouraged to try to correct the interference by one or more of the following measures:

- Re-orient or relocate the receiving antenna.
- Increase the separation between the fax equipment and the receiver.
- Connect the fax equipment on a separate circuit.
- Consult the dealer or an experienced radio/TV technician for help.

Brother cannot accept any financial or other responsibilities that may be the result of your use of this information, including direct, special or consequential damages. There are no warranties extended or granted by this document.

The serial number may be found on the label affixed to the back of the unit. For your convenience, note the number below and retain this owner's manual to serve as a permanent record of your purchase, in the event of a theft or fire, or for future reference.

MODEL NO. IntelliFAX615/625/635/675/715M/725M _____

NAME OF DEALER _____

DATE OF PURCHASE _____

Important Safety Instructions

1. Read all of these instructions
2. Save them for later reference.
3. Follow all warnings and instructions marked on the product.
4. Unplug this product from the wall outlet before cleaning. Do not use liquid or aerosol cleaners. Use a damp cloth for cleaning.
5. Do not use this product near water.
6. Do not place this product on an unsuitable cart, stand, or table. The product may fall, causing serious damage to the product.

IMPORTANT INFORMATION

7. Slots and openings in the cabinet and the back or bottom are provided of ventilation; to ensure reliable operation of the product and to protect it from overheating, these openings must not be blocked or covered. The openings should never be blocked by placing the product on a bed, sofa, rug, or other similar surface. This product should never be placed near or over a radiator or heater. This product should not be placed in a built-in installation unless proper ventilation is provided.
8. This product should be operated from the type of power source indicated on the label. If you are not sure of the type of power available, consult your dealer or local power company.
9. This product is equipped with a 3-wire grounding type plug, a plug having a third (grounding) pin. This plug will only fit into a grounding-type power outlet. This is a safety feature. If you are unable to insert the plug into the outlet, contact your electrician to replace your obsolete outlet. Do not defeat the purpose of the grounding-type plug.
10. Do not allow anything to rest on the power cord. Do not locate this product where persons will walk on the cord.
11. If an extension cord is used with this product, make sure that the total ampere ratings on the products plugged into the extension cord do not exceed the extension cord ampere rating. Also, make sure that the total of all products plugged into the wall outlet does not exceed 15 amperes (U.S.A. only).
12. Never push objects of any kind into this product through cabinet slots as they may touch dangerous voltage points or short out parts resulting in a risk of fire or electric shock. Never spill liquid of any kind on the product.
13. Do not attempt to service this product yourself, as opening or removing covers may expose you to dangerous voltage points or other risks. **Refer all servicing to service personal at 1-800-284-4FAX (4329).**
14. Unplug this product from the wall outlet and refer servicing to qualified service personnel under the following conditions:
 - A. When the power cord or plug is damaged or frayed.
 - B. If liquid has been spilled into the product.
 - C. If the product has been exposed to rain or water.
 - D. If the product does not operate normally when the operating instructions are followed. Adjust only those controls that are covered by the operating instructions since improper adjustment of other controls may result in damage and will often require extensive work by a qualified technician to restore the product to normal operation.
 - E. If the product has been dropped or the cabinet has been damaged.
 - F. If the product exhibits a distinct change in performance, indicating a need for service.

13. INDEX

- A**
- ACS Check Sheet 10-1
 Activity Report 10-2~3
 ADF 6-2
 All Dial List 10-3~4
 Answer Mode 2-4, 7-1
 Auto Mode 7-1~2
- B**
- Battery (Memory storage) 4-8
 Beeper 4-1~2
 Broadcasting (715M/725M) 6-8~9
- C**
- Call Back Message 6-19, 10-1
 Caller ID 7-16~19
 Call Reservation 6-18
 Canceling 6-11
 Chain Dialing 4-6
 Cleaning 11-1
 Connecting 1-6, 7-7, 7-10
 Contrast 6-3
 Control Panel Keys 2-1~4
 Copy 2-3, 9-1~2
 Cover Page 2-4, 3-4, 6-14~17, 10-1
- D**
- Daily Timer 6-7~8
 Date and Time 4-2
 Delayed Transmission 6-7
 Delayed Polling 8-5
 Distinctive Ringing 7-12~15
 Document 6-1
- E**
- ECM 6-20
 Error Re-Transmission 6-20
 Error Messages 11-4
 External Telephone 7-7, 7-10
 Extension Telephone 7-7
- F**
- Fine 6-2, 6-12~13
 F/T Mode 7-1, 7-3
 F/T Ring Time 7-4
 Function 2-4, 3-1~5
- G**
- Gray Scale 6-13
 Group 4-8~9
- H**
- HELP 2-4, 3-1, 3-6~7
 Hook 2-2, 5-1
 Hold 2-2, 5-1
- I**
- Interrupting 3-5, 6-10
 Interval 10-2
- J**
- Jacks 1-6, 7-7
 Jam 11-2~3
- L**
- Loading Paper 1-5
- M**
- Manual Mode 7-1~2
 Manual Dial 5-1
 Memory 6-6~9
 Memory transmission 6-6~9
 MEMORY FULL 9-2, 10-5
 Multiple Resolution Transmission ... 6-12~13
- N**
- Next-FAX Reservation 6-21
- O**
- One-touch Dial 2-3, 4-4~5, 5-1, 6-4
 On-Screen Programming 3-1
 On Hook Dial 5-1

Out of Paper Reception	7-6	Tone/Pulse	4-1
Overseas Mode	6-12		

P

Packing List	1-5
Pause	2-2, 4-5, 5-1
PBXs	1-9, 4-8
Photo	6-2, 6-12~13
Polling	8-1~5
Power	1-6, 14-1
Printing	3-6, 6-16, 6-19, 10-1~5

Q

Quick-Scan	2-4, 6-6~9
------------------	------------

R

Redial	2-2, 6-5
Remote Activation	7-7~9
Remote Code	7-7~9
Remote Deactivation	7-7~9
Reports	10-1~5
Resolution	2-4, 6-2, 6-12, 9-1
Ring Delay	7-2
Ring Time	7-4
Ring Volume	7-5

S

Secure Polling	8-3
Setting Up	1-5~7
SHIFT	2-3, 4-4
Smoothing	7-4
Speaker Volume	7-5
Speed Dial	2-2, 4-6~7, 5-1, 6-4
Station ID	4-3, 6-14
Standard Mode	6-2
Super Dark Mode	6-3
Super Fine Mode	6-2
Super Light Mode	6-3

T

Telephone Index (FAX-715M/725M)	5-2
Timer	6-7~8
Transmission Verification Report	10-4~5

14. SPECIFICATIONS

Type	Desktop facsimile transceiver
Compatibility	ITU-TS Group 3
Coding system	Modified Huffman (MH)
Modem speed	14400/12000 (for FAX-725M Only)/ 9600/7200/4800/2400; Automatic Fallback
Document input width	148 mm to 216 mm (5.8 inches to 8.5 inches)
Scanning/Printing width	208 mm (8.2 inches)
Paper roll size : Width	216 mm (8.5 inches)
Length	50 m (164 feet) with standard thermal paper 50 m (164 feet) with Therma PLUS paper
Printer type	Line thermal
Gray scale	64 levels (for FAX-635/675/715M/725M) 16/32 levels (for FAX-615/625)
Paper cutter	Automatic
Display	LCD, 16 characters
Polling types	Standard, Secure, Delay
Contrast control	Automatic/Super Light/Super Dark (manual setting)
Resolution	<ul style="list-style-type: none"> • Horizontal 8 dot/mm (203 dot/inch) • Vertical Standard 3.85 line/mm (98 line/inch) <ul style="list-style-type: none"> Fine, Photo (16 levels transmission) 7.7 line/mm (196 line/inch) Superfine, Photo (copy/32 levels transmission) 15.4 line/mm (392 line/inch)
One-touch dial	10 stations (for FAX-615) /20 stations (for FAX-625/635/ 675/715M/725M)
Speed-dial	20 stations (for FAX-625) /30 stations (for FAX-615/635) / 40 stations (for FAX-675/715M/725M)
Automatic redial	3 times at 5 minute intervals
Speaker type	Monitor
Auto answer	0, 1, 2, 3 or 4 rings
Communication source	Public switched telephone network
Operating environment	41 - 95° F
Power source	120V AC 50/60Hz (U.S.A., Canadian Version Only)
Power consumption	Standby: under 10 watts Peak: under 110 watts
Dimensions	377 x 304 x 121 (mm)/14.8 x 12 x 4.8 (inches)
Weight	3.4 kg/7.5 lbs

Specifications are subject to change for improvement without prior notice.

- Never install telephone wiring during a lightning storm.
- Never install telephone jacks in wet locations unless the jack is specifically designed for wet locations.
- Never touch uninsulated telephone wires or terminals unless the telephone line has been disconnected at the network interface.
- Use caution when installing or modifying telephone lines.
- Avoid using a telephone (other than a cordless type) during an electrical storm. There may be a remote risk of electric shock from lightning.
- Do not use the telephone to report a gas leak in the vicinity of the leak.

brother®

Brother International Corporation
200 Cottontail Lane,
Somerset, NJ 08875-6714, U.S.A.

Brother International Corporation (Canada) Ltd.
1 rue Hôtel de Ville,
Dollard-des-Ormeaux, QC, CANADA H9B 3H6

* Manufactured by Brother Industries Ltd. whose quality system
is registered by BSI and JQA.

BSI Certificate of registration No. FM27214
JQA Certificate of registration No. JQA-0367

UF5602001
Printed in Japan